

Multi-line lubrication systems

Product catalogue



Table of content

Two leading brands	4	Overview of control units51
Lubricants suitable for lubrication systems	5	IGZ/EXZT52
Multi-line lubrication systems for oil	6	EOT-254
Multi-line lubrication systems for grease	8	LMC255
		LMC301	56
Overview multi-line oil pumps and pump units11	Overview of monitoring devices	59
SP/G12	SP/SFE 30	60
RA... U14	EWT2A61
55i16	234-11145-3/4/5/9	62
JM18	234-10825-8	63
PDYY, PDYC, PDYE and PDYS	20	Index	64
PC	22		
RA... M/RAB	24		
SP/PFE	28		
Overview multi-line grease pumps31		
PFHM-ATEX32		
RA20/45	34		
P205	36		
FF	38		
P212	40		
P215	42		
FB/FB-XL44		
FB-XL	46		
P230	48		

Navigation

Introduction	2
Pumps units for oil	11
Pumps units for grease	31
Control units	51
Monitoring devices	59

Two leading brands



One global leader

SKF and Lincoln have joined forces to provide you with the world's most complete portfolio of innovative lubrication solutions – from manual lubricators and tools, to the most advanced centralized and automatic lubrication systems available.

In addition to traditional lubrication products and systems, we offer customized solutions for many industries such as pulp and paper, steel, mining, agriculture, marine, rail, wind, construction, machine tool and automotive. SKF engineering and technical specialists partner with OEMs and end-users to develop system solutions based on customer requirements. We also offer a variety of control and monitoring equipment for ease of use and to help ensure proper lubrication.

Both SKF and Lincoln systems are available through our global network of lubrication experts, offering you world-class installation and ongoing support on a local level – today and into the future. With the power of this network, and more than 200 years of combined friction management experience, we can help you improve machine reliability, reduce maintenance, increase productivity, enhance safety and optimise manpower resources.

Lubricants suitable for lubrication systems

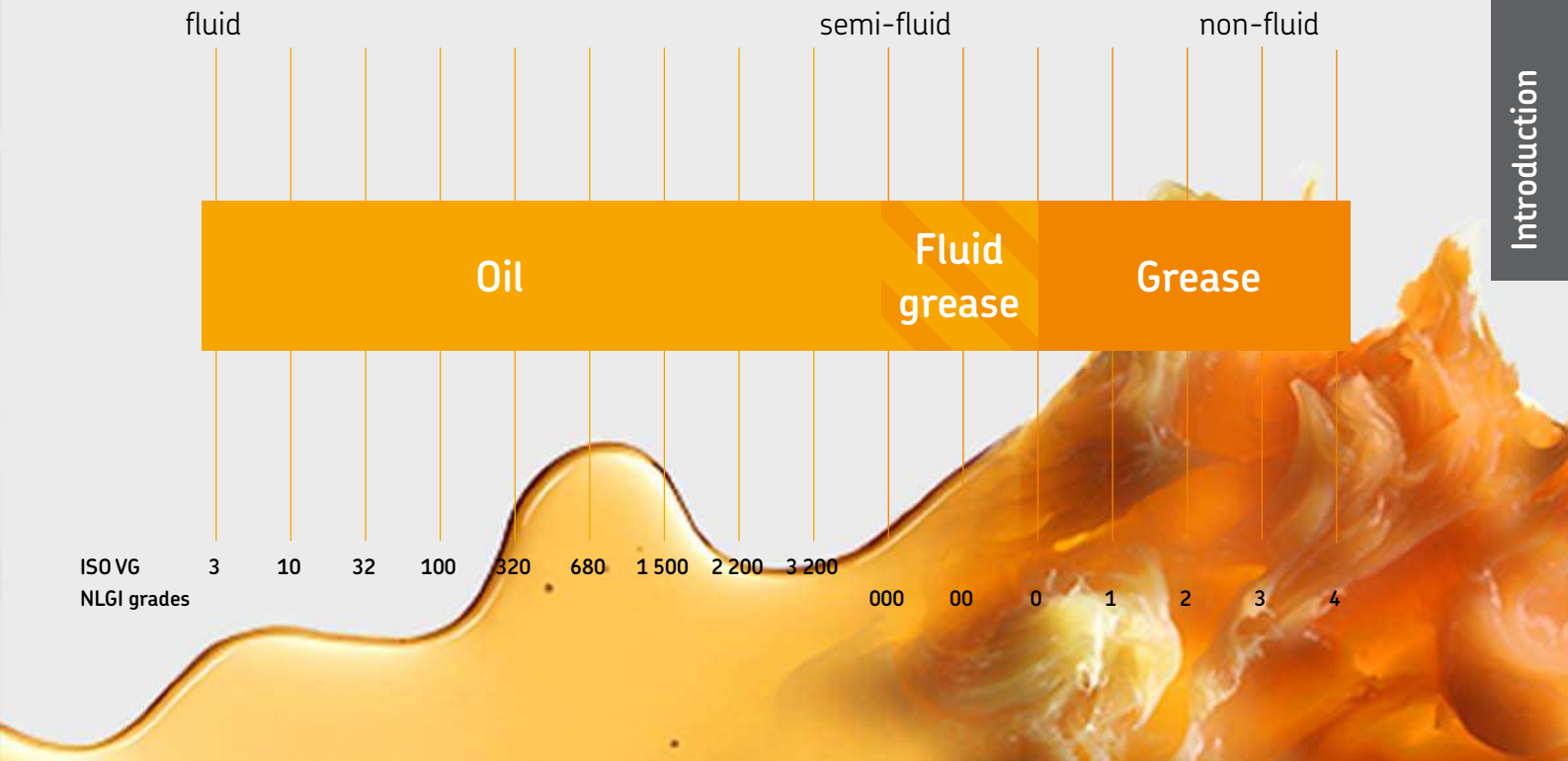

Oil and fluid grease

The viscosity is an expression of a fluid's internal friction. Oils are classified in ISO VG viscosity classes from 2 to 3 200. NLGI grade 000, 00 and 0 greases are called fluid greases. Different types of oils are available, including mineral oils, organic oils and synthetic oils. A compatibility check is recommended prior to using any oil with SKF lubrication systems.



Grease

Greases are consistent lubricants (NLGI grade 1–6). They are soft to hard, triple-component mixtures of a base oil as the lubricating fluid, a thickening agent and additives. In most instances, greases of NLGI grade 1 up to 3 are suitable for use in a lubrication system. A compatibility check should be made prior to using any grease with SKF lubrication systems.

Multi-line lubrication systems for oil

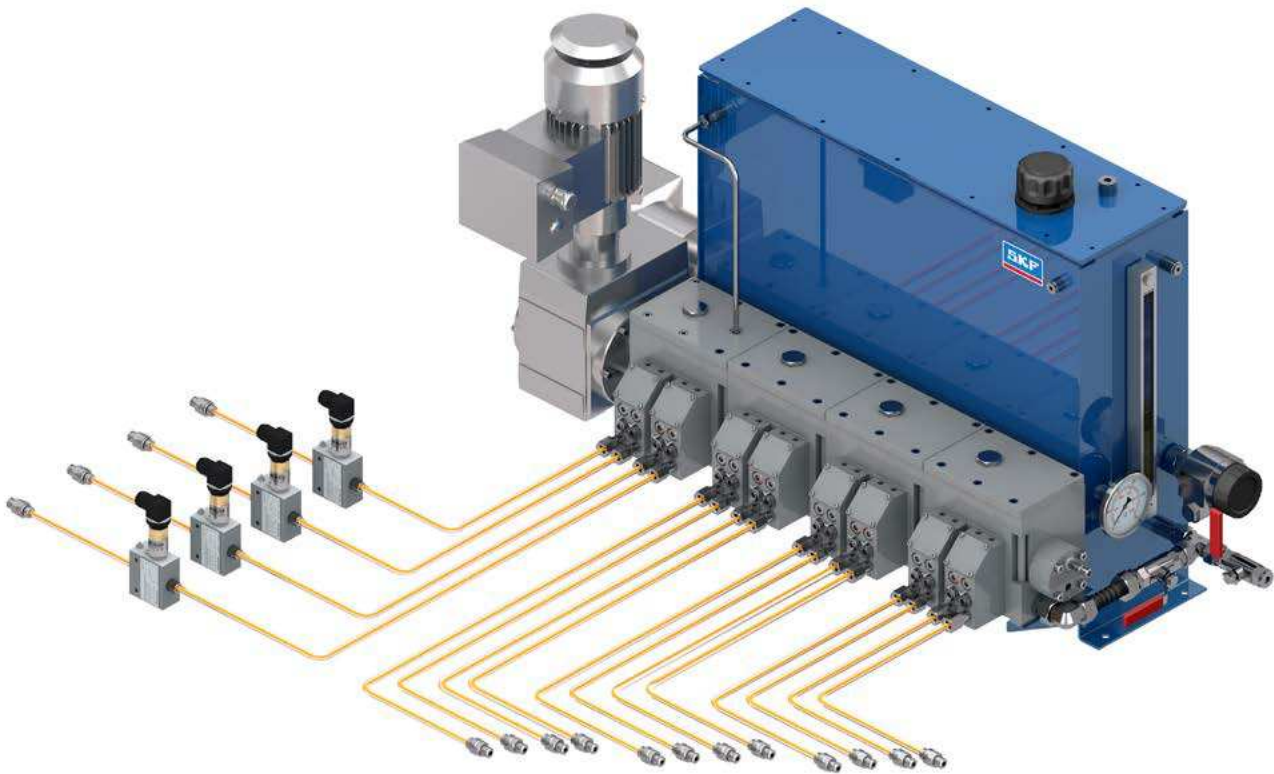

System description

SKF multi-line lubrication systems consist of the following components: a pump unit, control and monitoring devices, tubing and fittings. Multi-line pump units supply lubricant to lubrication points without extra metering dividers. Thus, each lubrication point has its own pumping element. The system design is simple, accurate and most reliable.

Multi-line pumps can be actuated mechanically, electrically or hydraulically. The easily exchangeable pumping elements are usually operated by eccentric cam. Depending on drive speed, gearbox ratio and selected pump element size, a delivery range from almost 0 to 227 cm³/min (0 to 13,85 in³/min) can be covered.

By selecting pumping elements with different piston diameters and/or stroke settings, an individual lubrication volume setting per pump outlet is possible. The potential number of outlets ranges from 1 to 28.

SKF multi-line oil pumps are designed for demanding applications in nearly all industries and for pressure requirements up to 4 000 bar (58 000 psi).

Advantages:

- Sturdy; durable pump series designed for 24/7 operation
- Simple; continuous lubrication without electrical cycle timers, in most cases
- Versatile; select individual pump element characteristics and oil reservoir size
- Precise; set the required stroke volume at the pumping element
- High delivery speed in milliseconds for timed and pinpointed lubrication (PD series)
- Broad viscosity range due to special designs and small piston clearance
- ATEX explosion-proof versions available
- Extra, downstream-located flow control valves or progressive metering devices possible



Applications

SKF Multi-line oil pumps are sophisticated and have a long tradition going back to applications in steam-driven locomotives. Currently, they deliver the superior reliability standard required in high-stressed machines in sensitive areas with extreme vibrations, specially formulated oils, high lubrication point back pressures or certain safety regulations such as:

- Vacuum pumps, compressors (all types) and the hyper-compressor industry
- Combustion engines for valve and cylinder liner lubrication
- Important oil total-loss or very small oil circulation applications
- Rubber-mixing machinery, supply of critical plasticizer oil
- Meet ATEX and API standards in the oil and gas industry

Multi-line lubrication systems for grease

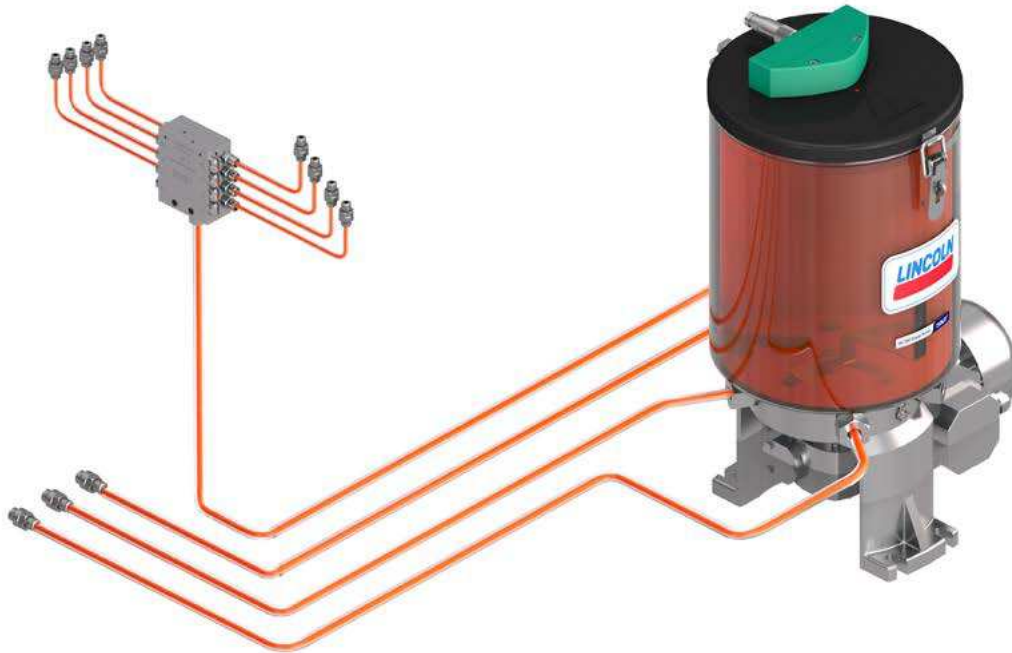

System description

SKF multi-line lubrication systems consist of the following components: a pump unit, control and monitoring devices, tubing and fittings. Multi-line pump units supply lubricant to lubrication points without extra metering dividers. Thus, each lubrication point has its own pumping element. The system design is simple, accurate and most reliable.

Multi-line pumps can be actuated mechanically, electrically or hydraulically. The easily exchangeable pumping elements are usually operated by eccentric cam. Depending on the drive speed, gearbox ratio and selected pump element size, a delivery range from almost 0 to 35 cm³/min (0 to 2.13 in³/min) can be covered. The built-in stirrer mixes the grease (grease softening process), is synchronized with the pump element suction stroke, and assists the heavy lubricant to flow into the suction chamber. This unique concept supplies heavy lubricants usually up to NLGI 3.

An individual lubrication volume setting per pump outlet is possible by selecting pumping elements with different piston diameters and/or stroke settings. The potential numbers of outlets range from 1 to 30.

SKF multi-line grease pumps are designed for demanding applications in nearly all industries. Most pump versions are available with special reservoirs for oil. The P 215 and P 230 pump series enable the use of plasticizer oil for the rubber industry.

Advantages:

- Sturdy; durable pump series designed for 24/7 operation
- Simple; continuous lubrication without electrical cycle timers, in most cases
- Versatile; select individual pump element characteristics and reservoir size
- Precise; set the required stroke volume at the pumping element
- Due to the use of a built-in stirrer and broad viscosity range, heaters are not required
- ATEX explosion-proof versions available
- Extra, downstream-located flow control valves or progressive metering devices possible



Applications

SKF Multi-line grease pumps have a long tradition in the heavy steel industry and meet ATEX standards for gas and dust. Their reliability standard is specified for high-stressed machinery in sensitive and/or dirty areas with pressure requirements up to 350 bar (5 075 psi) such as:

- Construction and mining machinery
- Tunnel-boring machines
- Forging, bending, forming and cutting presses
- Crushers, cranes and conveyors
- Pumps and compressors
- Rubber-mixing machinery
- Water and slurry pumps



SKF



Overview multi-line oil pumps and pump units

Mechanically operated pumps

Product	Outlets Reservoir		Metering quantity per outlet		Operating pressure max		ATEX ¹⁾	Page	
	l	gal	cm ³ /min	in ³ /min	bar	psi			
SP/G	2 or 4	on request	<i>on request</i>	0,14–2,9	0.008–0.176	3	44	–	12
RA ... U	1–20	on request	<i>on request</i>	0,07–36	0.004–2.196	63	913	• 2)	14
55i	1–14	1–8	0.26–2.1	0,2–12,7	0.012–0.775	400	5 800	–	16
JM	1–28	2–14; any	0.5–3.7; any	0,17–5,0	0.010–0.305	600	8 700	• 3)	18
SP/PFE	1–5	on request	<i>on request</i>	1,0–75,0	0.061–4.576	4 000	58 000	• 3)	28

¹⁾ on request

²⁾ for gas: II 2G c IICT4 Gb; for dust: II 2D c IICT 135°C Db

³⁾ for gas: II 2G c IICT4 Gb

Hydraulically operated pump units

Product	Outlets Reservoir		Metering quantity per outlet		Operating pressure max		Page	
	l	gal	cm ³ /min	in ³ /min	bar	psi		
PD ...	4–10	–	–	0–20	0–1.22	63	913	20
PC	1–28	–	–	1,74–227	0.106–13,852	50	725	22

Electrically operated pumps

Product	Outlets Reservoir		Metering quantity per outlet		Operating pressure max		ATEX ¹⁾	Page	
	l	gal	cm ³ /min	in ³ /min	bar	psi			
RA... M/RA B	1–20	0,3–15, any	0.8–4; any	0,07–36	0.004–2.196	60	870	• 2)	24
PC	1–28	–	–	1,74–227	0.106–13,85	50	725	–	22
JM	1–28	2–14; any	0.5–3.7; any	0,15–7,95	0.009–0.485	600	8 700	• 3)	18
SP/PFE	1–5	on request	<i>on request</i>	1,0–75,0	0.061–4.576	4 000	58 000	• 3)	28

¹⁾ on request

²⁾ for gas: II 2G c IICT4 Gb; for dust: II 2D c IICT 135 °C Db

³⁾ for gas: II 2G c IICT4 Gb

Pump

SP/G



Product description

The SP/G rotary-driven, multi-line piston pump features a fixed internal gear ratio of 33:1. Its compact pump design with only two rotating/movable parts is slide operated and requires no rubber seals, springs or additional non-return valves. The SP/G is available as a self-priming pump or as a pump with priming pressure. Designs with two or four outlets are available. The two-outlet version is offered in two different piston sizes respective of delivery volumes. One vibration-proof, stroke-regulating screw per outlet pair enables fine-tuned stroke settings.

Features and benefits

- Virtually maintenance-free, vibration-proof, 24/7 design
- Designed for high ambient temperatures and all standard lubrication oils
- Machine operated; no under- or over-lubrication
- Oil supply from machine sump or from existing oil-circulation system
- Adjustable output
- Available for two drive directions

Applications

- Marine industry; inlet valve seat lubrication for powerful four-stroke engines
- General machine-driven applications

Technical data

Function principle	mechanically operated piston pump
Metering quantity ¹⁾	piston K6: max. 0,042 cm ³ /stroke max. 0.0026 in ³ /stroke piston K7: max. 0,058 cm ³ /stroke max. 0.0035 in ³ /stroke
Group size	2, 4, 6, 8, 10 flow meters
Lubricant	mineral, synthetic, environmentally safe oil; up to 12 to 800 mm ² /s
Operating pressure	3 bar; 43 psi, plus inlet pressure
Inlet pressure	0 or 2 to 6 bar, 0 or 30 to 85 psi
Operating temperature	max. 100 °C; 212 °F
Outlets	2 or 4
Internal ratio	30:1
Drive speed	300-3000 min ⁻¹
Drive direction	left/right
Connection in/outlet	for tube ø 4 and 6 mm OD
Dimensions	2 outlets: 56 x 88,5 x 44 mm 2.22 x 3.5 x 1.8 in 4 outlets: 69 x 85 x 45 mm 2.7 x 3.4 x 1.8 in
Mounting position	any
Options	customized pre-set volumes

¹⁾ With priming pressure increased delivery volume; see technical information

NOTE

For further technical information, technical drawings, accessories, spare parts or product function descriptions, see the following publication available on SKF.com/lubrication: **951-170-219-EN**

Pump

SP/G

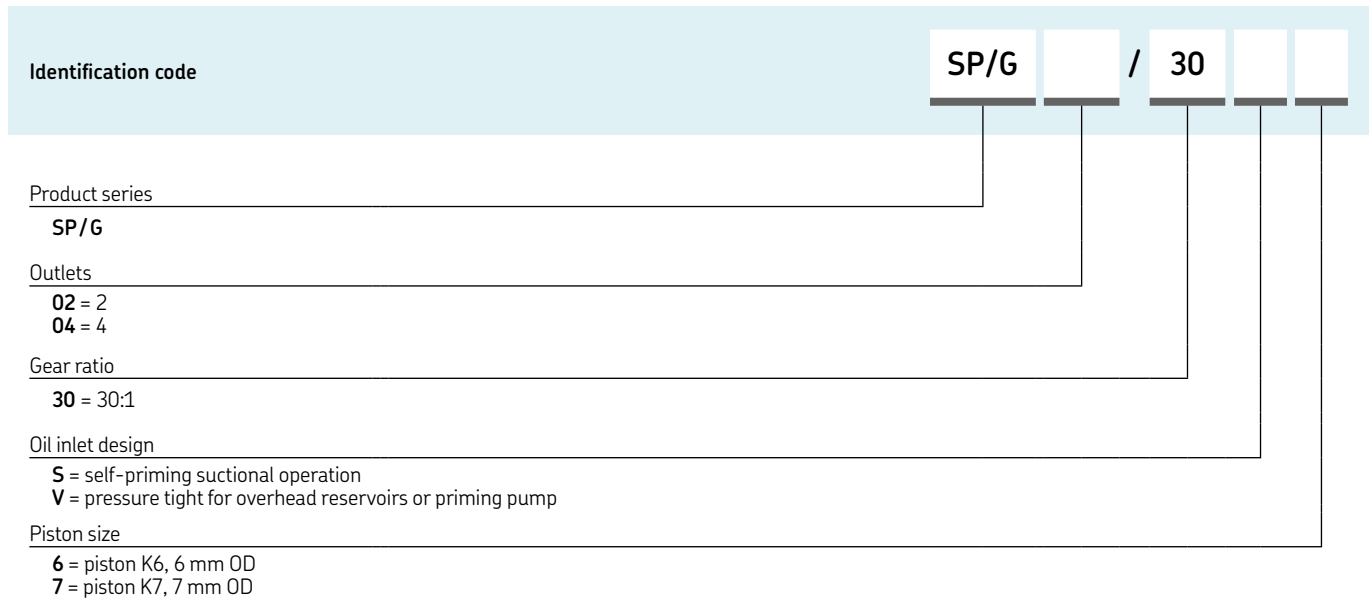

Pump units for oil

SP/G tube connections

Order number	Description
Inlet screw unions	
406-001	double-tapered ring for tube ø 6 mm OD
406-002	socket union M10×1 – tube ø 6 mm OD
Outlet screw unions	
404-001	double-tapered ring for tube ø 4 mm OD
404-002	socket union M8×1 tube ø 4 mm OD

SP/G coupling element with snap ring

Order number	Description	Item
44-1202-2038	coupling element	1
44-0606-6302	snap ring for coupling element	2



Pump

RA ... U



Product description

The RA multi-line pump is a unique radial piston pump with stackable pump elements. The modular pump design allows up to five pump elements, each with one, two or four outlets. A later outlet reduction or outlet extension is thus possible. The displacement of all outlets from a pump element is adjustable by a common setting device, setting range 33–100%. Several different mechanical or electric motor drives are available.

Features and benefits

- Modular pump-to-point solution for 1 to 20 lubrication points
- Depending on drive speed respective of selected drive ratio, RA pumps cover feed rates of some droplets until $36 \text{ cm}^3/\text{min}$ ($2.2 \text{ in}^3/\text{min}$)
- Drive direction left or right
- Compatible with mineral- and synthetic-based oil
- Vibration-proof, marine and ATEX versions available
- Supplies several different lubrication zones, lubrication points or chain pins

Applications

- Gas compressors and large pumps
- Economic power unit for sealing oil systems
- Marine, valve-seat lubrication on large four-stroke engines

Technical data

Function principle	radial piston pump with stackable pumping elements
Operating temperature	-15 to $80 \text{ }^\circ\text{C}$, $+5$ to $+176 \text{ }^\circ\text{F}$
Operating pressure	10 to 63 bar, 145 to 915 psi
Outlets	depending on drive speed and oil viscosity 1 to 20 (max. 5 elements with 1, 2 or 4 outlets)
Lubricant	mineral- and synthetic-based oil, 25 to 2 500 mm^2/s
Metering quantity per outlet	0,007–0,02 $\text{cm}^3/\text{revolution}$ 0,0004–0,0012 $\text{in}^3/\text{revolution}$
Output per outlet	0,07–36 cm^3/min 0,004–2,2 in^3/min
Internal ratio	1:1, 5:1, 10, 5:1, 15:1, 25:1, 75:1, 125:1
Dimensions	min. 113 × 54 × 54 mm max. 220 × 54 × 54 mm min. 4.45 × 2.13 × 2.13 in max. 8.68 × 2.13 × 2.13 in
Drive speed	10 to 1 800 min^{-1}
Protection class	min. IP 55
Mounting position	any
Options	with manual hand crank for pre-lubrication, customized pre-set volume version with two inlet sections for two different oil types



NOTE

For further technical information, technical drawings, accessories, spare parts or product function descriptions, see the following publications available on SKF.com/lubrication:

11103 EN, 951-170-230 EN

CAD data



skf-lubrication.partcommunity.com/3d-cad-models/

Pump

RA ... U

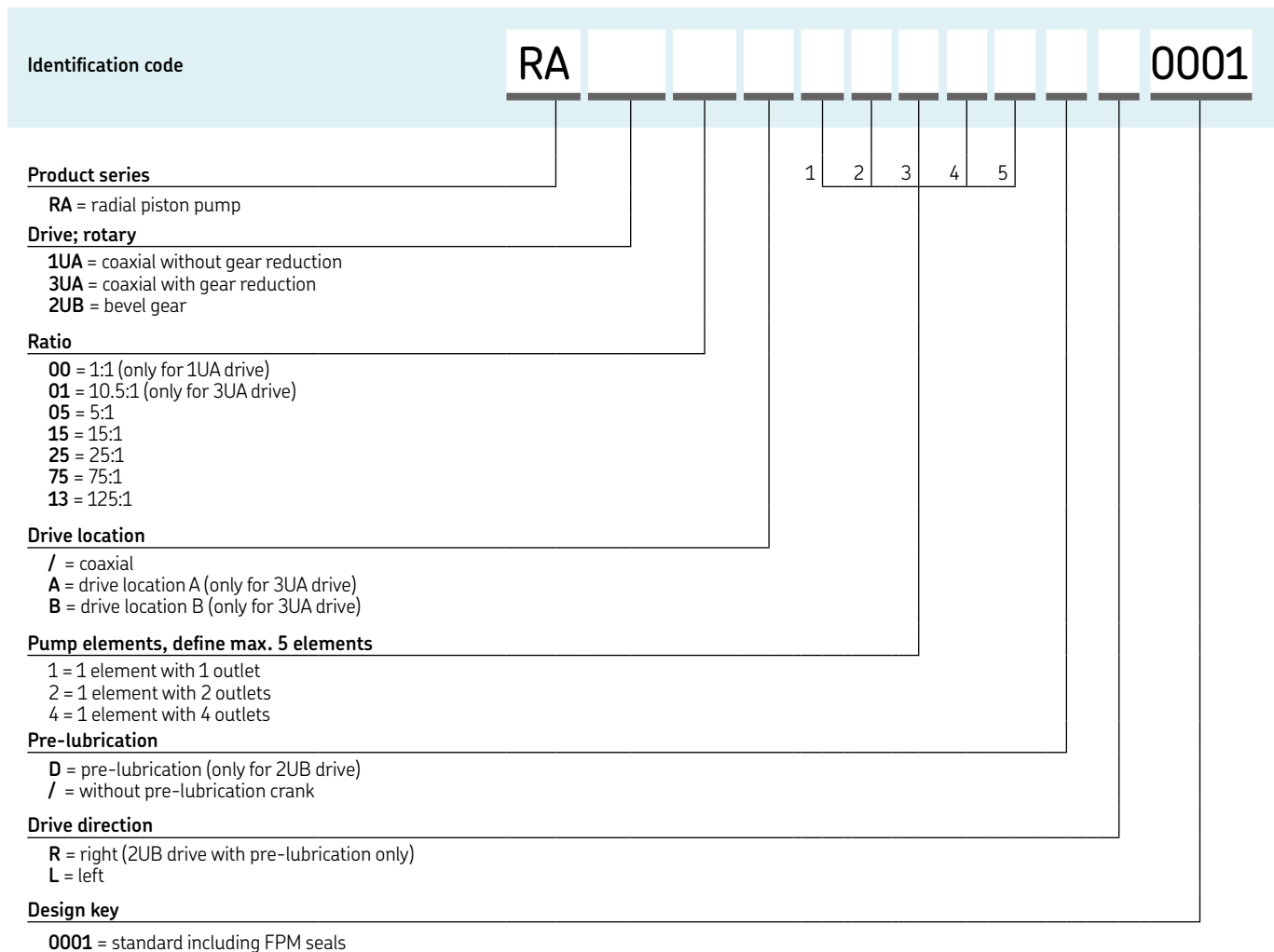

RA pump elements	
Order number	Description
24-1557-3520	pump element, with 1 outlet
24-1557-3521	pump element, with 2 outlets
24-1557-3522	pump element, with 4 outlets

Pump

55i



Product description

The positive-displacement, single-action 55i pumps are fully adjustable by means of manually modifying the angle of the rocker arm to the cam. The pump operation is a two-stage process. As the camshaft rotates, the cam mechanically forces the pump plunger forward, displacing a measured volume of oil. On the second or return stroke, a spring assists the plunger to return for prime. All pump elements are designed with a pushbutton for manual pre-lubrication.

Features and benefits

- Easy adjustment of flow rate
- Pushbutton for pre-lubrication and system de-aeration
- Modular box lubricator mounting for ease of maintenance
- Pumps with suction tube for oil suction from the lubricator box or with direct feed by overhead reservoir
- With or without sight glass for visual flow indication
- For operating viscosity up to 1 700 mm²/s

Applications

- Gas engines
- Reciprocating compressors
- High-pressure oil, total-loss lubrication systems

Technical data

Function principle	camshaft-operated piston pump
Metering quantity	K 3/16: 0,20 cm ³ , 0.0122 in ³ K 1/4: 0,302cm ³ , 0.0184 in ³ K 3/8: 0,68 cm ³ , 0.0415 in ³
Outlets	1 to 7
Lubricant	mineral- or synthetic-based oil, viscosity max. 1 700 mm ² /s
Operating pressure	K 3/8: max. 240 bar, 3 500 psi K 1/4: max. 400 bar, 6 000 psi
Operating temperature	-20 to +70 °C, -4 to + 158 °F
Reservoir	1,4 to 3,8 l, 0.37 to 1.0 gal depends on outlet quantity
Internal ratio	37.5:1; 60:1; 112.5:1
Drive speed	<20 min ⁻¹ ; depends on box lubricator
Electrical motor drives	for pumps with 112.5:1 and 300:1 ratio only
Connection outlet	1/8 NPTF
Dimensions	min. 127 × 88 × 35 mm max. 127 × 132 × 35 mm min. 5 × 3 15/32 × 1 3/8 in max. 5 × 5 3/16 × 1 3/8 in outer parts when installed in box lubricator
Mounting position	vertical
Options	pumping elements without sight glass lubrication sentries to control the oil-level and camshaft rotation, oil-level regulator

NOTE

For further technical information, technical drawings, accessories, spare parts or product function descriptions, see the following publication available on SKF.com/lubrication:
FORM 442834 EN

Pump

55i

Identification code

55i

Product series
55i = camshaft-operated piston pump

Reservoir
3 = 1,4 l, 3 pint, max. 3 single pumps
4 = 1,9 l, 4 pint, max. 5 single pumps
8 = 3,8 l, 8 pint, max. 7 single pumps

Drive / gear ratio / available reservoir size / speed

Designation	Drive	Ratio	Reservoir		Speed
			l	pt	
A = rotary drive, internal gear and ratchet	right or left	37,5:1	1,9 3,8	4,8 9,6	700
B = internal ratchet and external lever	right or left	75 teeth	1,9 3,8	4,8 9,6	1100
C = internal super gear, pulley, machine drive	right or left	112,5:1	1,9 3,8	4,8 9,6	1200
D = external gear drive, specific OEM frame	right or left	60:1	1,9	4,8	1200

Single Pumps

Designation	Piston ø		Inlet	Sight glass	Operating pressure max.		Metering quantity per stroke max.			Order number spare part
	mm	inch			bar	psi	drops	cm ³	in ³	
1 = vacuum feed	6,4	1/4	suction tube •	•	400	6 000	9	0,302	0.0184	880550
2 = vacuum feed	9,5	3/8	suction tube •	•	240	3 500	21	0,680	0.0415	880560
3 = pressure inlet, manifold feed	4,8	3/16	1/8 NPTF •	•	400	6 000	6	0,200	0.0122	880553
4 = pressure inlet, manifold feed	6,4	1/4	1/8 NPTM •	•	400	6 000	9	0,302	0.0184	880551
5 = pressure inlet, manifold feed	9,5	3/8	1/8 NPTM •	•	240	3 500	21	0,680	0.0415	880561
6 = direct feed	6,4	1/4	1/8 NPTF -	-	400	6 000	9	0,302	0.0184	880552
7 = direct feed	9,5	3/8	1/8 NPTF -	-	240	3 500	21	0,800	0.0488	880554

55i accessories

Description	Order number
lubricator flow switch; monitors model 55i lubricant flow	880463
lube sentry; monitors camshaft rotation and reservoir level	880555
lube sentry; same as model number: 880555, except suction is 1/2 inch shorter, for pre-warning	880556
oil-level regulator; automatically fills lubricator reservoir from header reservoir	880496
cover plate; gasket	350654
cover plate assembly	250132
cover plate screws	70224
armored sight glass kit	276517

Pump unit

JM



Product description

The multi-line JM oil lubrication pump is a high-pressure pump that provides a maximum continuous operating pressure of 600 bar (8 700 psi). Its modular design features unique, adjustable, dual-piston pumping elements (separate dosing and high-pressure booster piston) in combination with an optical drip indicator that delivers outstanding reliability.

Depending on the application, the pump can be machine or electrically driven. The JM pump is available in a pressure-tight design that is suitable for use with overhead lubrication oil tanks. It can deliver all mineral oils with an operating viscosity between 25 and 3 000 mm²/s.

Features and benefits

- Designed for 24/7 operation
- Three piston sizes cover output from 0,17 to 5,0 cm³/min (0.01 to 0.29 in³/min) per outlet
- Individual outlet settings between 25 and 100%
- Pressure-tight design available
- Can be monitored according to API 618 standards
- Most reliable replacement for all standard box lubricators

Applications

- Reciprocating gas compressors, mainly in an ATEX environment
- Pump-to-point lubrication of packings and cylinders
- Petro-chemical and food and beverage industry

Technical data

Function principle	cam-operated piston pump in modular design, rotary or electrically operated
Metering quantity per stroke	0,017–0,2 cm ³ , 0.001–0.012 in ³
Outlets	1 to 28
Lubricant	mineral- or synthetic-based oil, 25 to 3000 mm ² /s
Operating pressure	max. 600 bar, 8 700 psi
Operating temperature	0 to +40 °C, +32 to +104 °F
Protection class	min. IP 55F, ATEX available
Reservoir	per module 2 l, 0.5 gal
Internal ratio	1:1, 35.1:1, 62.8:1, 83.2:1, 100.9:1, 125.7:1
Drive speed main shaft n ₂	10 to 25 min ⁻¹
Metering quantity per outlet	0,17–5,0 cm ³ /min, 0.01–0.305 in ³ /min
Drive	3-phase motor or mechanical
Outlet connections	G 1/4, tube ø 6 or 8 mm OD
Dimensions	min. 315 × 200 × 260 mm max. 1 455 × 200 × 260 mm min. 12.4 × 7.87 × 10.24 in max. 57.3 × 7.87 × 10.24 in
Mounting position	horizontal, level surface
Options	pressure-tight design for overhead reservoirs, additional oil reservoir with heater and oil-level sensor, camshaft rotation sensor, oil flow pulse transmitters in ATEX

NOTE

For further technical information, technical drawings, accessories, spare parts or product function descriptions, see the following publication available on SKF.com/lubrication:

951-170-019; 951-180-073; 14600; 1-3007

Pump unit

JM

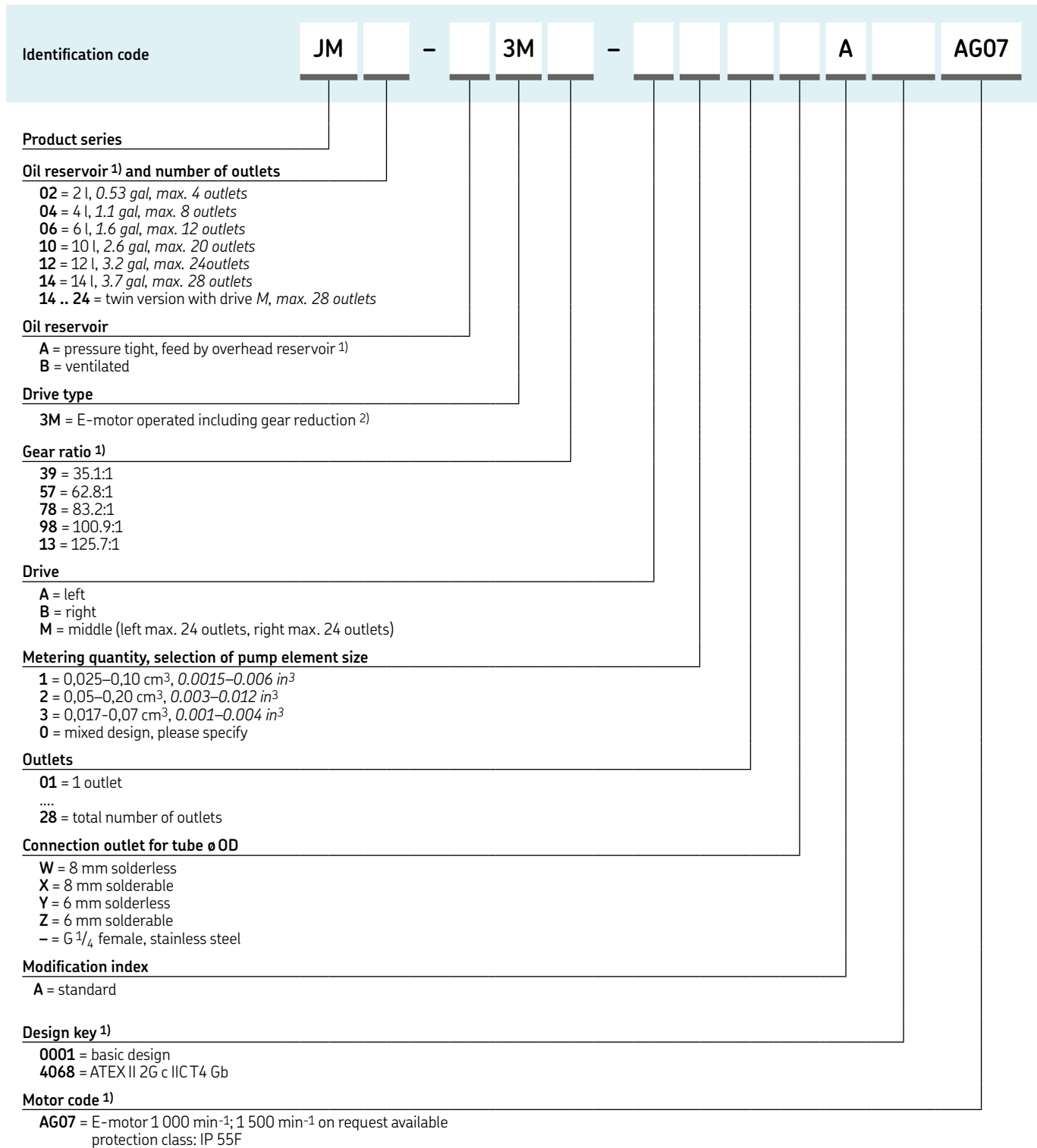

¹⁾ For supply via additional or overhead reservoir (max. installation height of 10 m; 5 m in conjunction with an additional reservoir in steel design)
²⁾ For direct machine-operated versions, please consult technical support

Pump unit

PDYY, PDYC, PDYE and PDYS



Product description

Designed for high-speed cylinder lubrication on two-stroke engines, the PDY... pumps use an existing oil supply system or drive pump unit. Engine electronics trigger the pre-loaded pumps by activating the solenoid valve. The exact stroke volume can be synchronized with the moving engine piston, and ignition timing can be adjusted to reach various piston stress areas with oil.

PDYY and PDYC pumps feature a baseplate configuration with 6 or 8 outlets. The PDYE serves engines with 6, 8 or 10 lubrication points per cylinder. PDYS pumps have double-stroke functionality for use on small-bore engines with only 4 outlets per cylinder.

Features and benefits

- Accurate, timed oil metering quantities within a millisecond
- Load-dependent, lubrication standard
- Modular design for easy assembly and service
- Prevents over-lubrication, deposits, excess smoke and CO₂
- Provides up to 40% oil savings
- Retrofit solutions available

Applications

- Marine industry
- General industry
- Chains or compressors

Technical data

Function principle	electrically/hydraulically operated multi-outlet pump
Metering quantity	40 to 310 mm ³ 0.0024 to 0.019 in ³
Outlets	PDYS: 4 PDYY, PDYC: 6 or 8 PDYE: 6, 8 or 10
Lubricant	mineral-based oil up to SAE50; 25 to 2000 mm ² /s
Drive oil	PDYS: supply unit with lubricating oil PDYY, PDYC, PDYE: mineral-based system oil up to SAE30
Operating pressure	45 to 55 bar; 650 to 800 psi
Operating temperature	+5 to 70 °C; +41 to 158 °F
Injection time	PDYS, PDYE: <5 ms; PDYY, PDYC: <8 ms
Power supply	24 V DC
Protection class	IP 65
Mounting position	PDYY/C/S outlets on top PDYE outlets horizontal
Dimensions	max. 270 × 261 × 180 mm max. 10.6 × 10.3 × 7.1 in
Options	oil drive units with redundant pumps according to the marine standard

NOTE

For further technical information, technical drawings, accessories, spare parts or product function descriptions, see the following publications available on SKF.com/lubrication:

PDYY; System CLU4: **951-130-314 EN**

PDYC; System CLU4C: **951-160-012 EN**

PDYE; System CLU4eco: **951-170-225 EN**

PDYS; System CLU5: **951-170-210 EN**

Pump unit

PDYY, PDYC, PDYE and PDYS

Identification code

Product series

- PDYY = electrically/hydraulically operated pump; (CLU4)
- PDYC = electrically/hydraulically operated pump; compact design (CLU4C)
- PDYE = electrically/hydraulically operated pump; flange design (CLU4eco)
- PDYS = electrically/hydraulically operated pump; small design (CLU5)

Outlets

- 04 = 4 outlets
- 06 = 6 outlets
- 08 = 8 outlets
- 10 = 10 outlets

Engine bore size

- 35 = 35 cm, 13.78 in
- 40 = 40 cm, 15.75 in
- ...
- 96 = 96 cm, 37.79 in
- XX = engine size independent

Accumulator

- A = 0,75 l, 0.2 gal
- B = 0,32 l, 0.085 gal, for PDYY and PDYC
- X = without

Metering quantity per stroke

PDYS:	PDYY, PDYC:
40 = 40 mm ³ ; 0.0024 in ³	90 = 90 mm ³ ; 0.0055 in ³
60 = 60 mm ³ ; 0.0037 in ³	110 = 110 mm ³ ; 0.0067 in ³
	150 = 140 mm ³ ; 0.0092 in ³
PDYE:	...
60 = 60 mm ³ ; 0.0037 in ³	310 = 310 mm ³ ; 0.019 in ³
...	
230 = 230 mm ³ ; 0.014 in ³	

Outlet connection for tube ø OD

A = 6 mm	C = 10 mm
B = 8 mm	/ = without outlet connection

Design key

- 0201 = basic version without bracket
- 4XXX = special version

Solenoid valve

- 24DC = voltage 24 V DC

PDYY, PDYC, PDYE and PDYS accessories

Order number	Pump	Description
161-140-050+924	PDY/Y/C/E	solenoid valve
161-140-056+924	PDYS	solenoid valve
24-1884-2324	PDY/Y/C/E	pressure sensor
24-1884-2397	PDYS	pressure sensor
24-2578-2041	PDYC	accumulator: 0,32 l; 0.085 gal
24-2578-2044	PDYY	accumulator: 0,75 l; 0.2 gal

Pump unit

PC

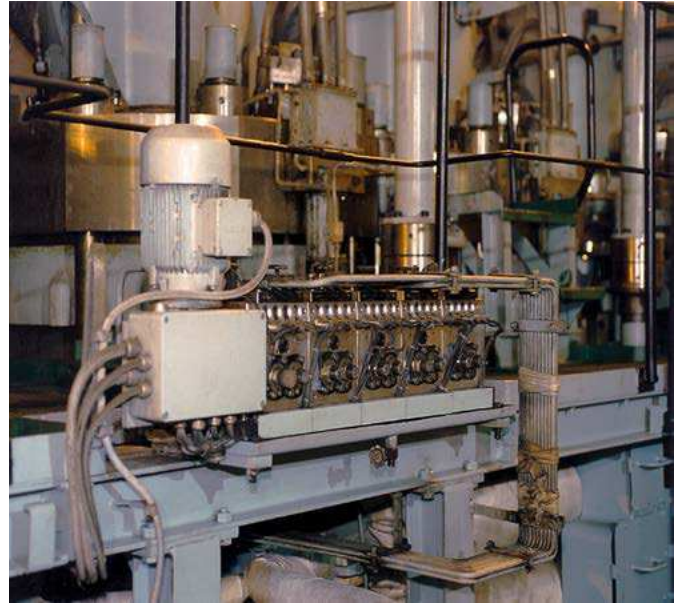

Product description

Designed for total-loss lubrication systems with significant oil volume requirements, the PC pump unit features from 1 to 28 outlets. Delivery volume can be sub-divided using a progressive-type metering device, enabling the pump to cover up to 224 lubrication points. This all-in-one pump unit consists of a frequency-controlled E-motor with gear reduction, pump modules with pumping elements for six pre-defined settings, optical/electrical flow controls, additional sensors for low level and optional drive speed, safety valves and connections for heating oil. Its integrated shut-off valves, one per module, allow the use of different lubricating oil and/or pumping element replacement during operation. The terminal box with pre-wired sensors contains a pushbutton for pre-lubrication.

Features and benefits

- Accurate, robust lubrication pump assembly
- Load-dependent, variable-speed operation as standard
- E-motor with electrically operated air fan enables wide speed range
- Ease of operation, maintenance and assembly
- Assembly brackets for hanging or standing position
- 24/7 operation in arctic and tropical conditions

Applications

- Marine industry

Technical data

Function principle	modular electrically or hydraulically operated piston pump unit in marine standard, with non-flow sensors and oil-heating connections
Metering quantity per outlet	1,74–227 cm ³ /min, 0.1–14 in ³ /min
Outlets	1 to 28
Lubricant	mineral oil up to SAE 5012 to 2 000 mm ² /s
Lubricant supply	by overhead reservoir, max. inlet pressure 2 bar, 30 psi
Operating pressure	max. 50 bar, 725 psi
Operating temperature	+5 to 45 °C, +41 to 113 °F
Internal ratio	4.83; 14.5; 19; 29; 38; 51; 62 : 1
Output per Outlet	0,27–1,1 cm ³ , 0.016–0.067 in ³
Electrical connection Sensor	24 V DC
Hydraulic drive option	100 cm ³ /revolution, 60–360 min ⁻¹ for i = 4.81:1 and 7.25:1 only
Protection class	IP 55F
Connection	inlet: G 1 1/4 outlet: G 1/4 for tube ø 10 mm OD
Dimensions	min. 610 × 513 × 320 mm max. 610 × 1 580 × 320 mm min. 24 × 20.2 × 25.6 in max. 24 × 62.2 × 25.6 in
Mounting position	horizontal
Options	version with mainshaft revolution; sensor; sensors NPN instead of NAMUR



NOTE

For further technical information, technical drawings, accessories, spare parts or product function descriptions, see the following publication available on SKF.com/lubrication:

951-170-208

Pump unit

PC

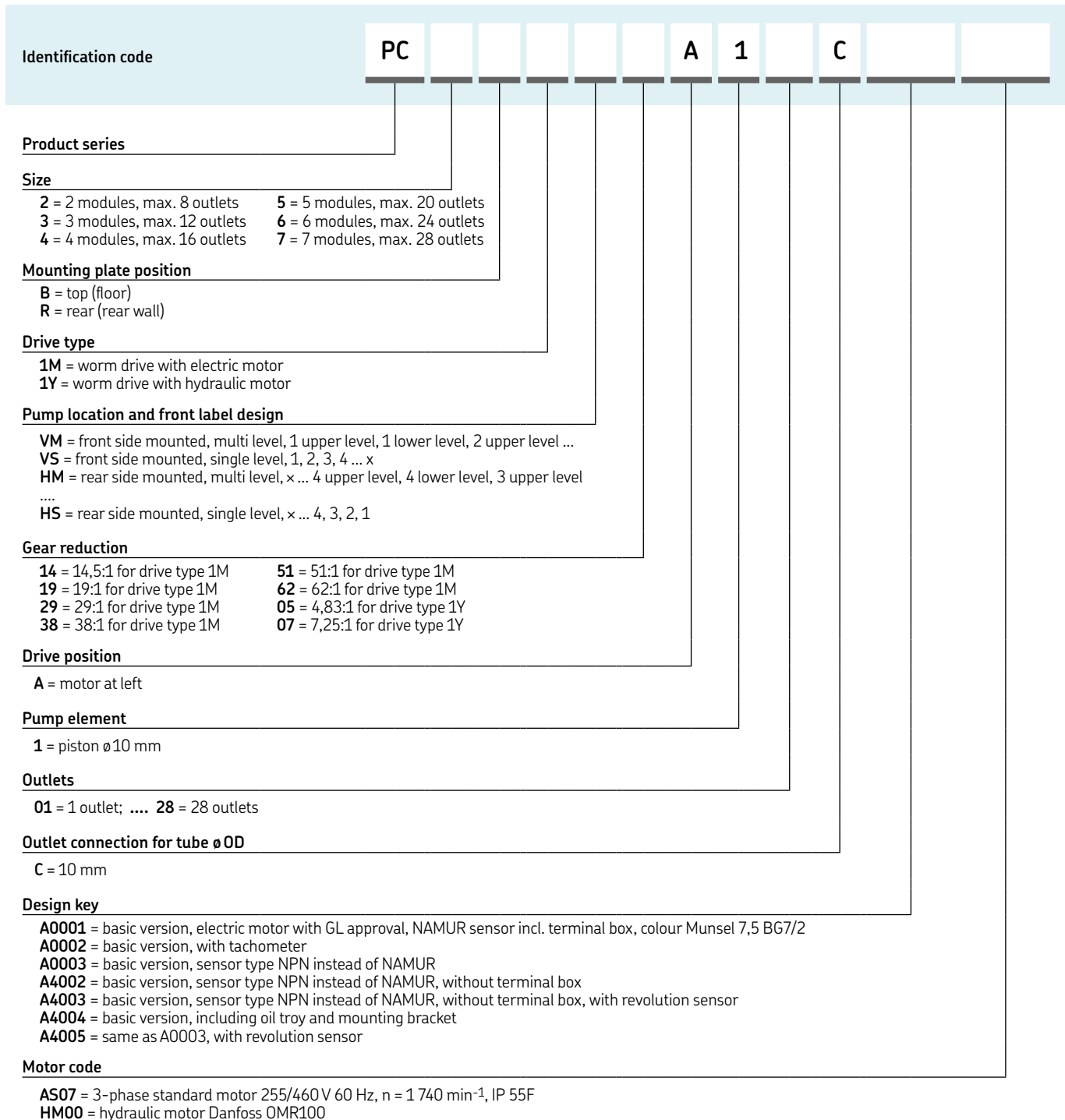

PC accessories

Order number	Description
24-0404-2493	gasket set with seals
24-1557-3560	spare pumping element
24-1751-2760	filter assembly, 100 μ m
24-0651-3519	filter element only

Pump unit

RA ... M/RA B



Product description

The RA radial piston pump features a modular design that enables use of up to five stackable pump elements, and outlet reduction or expansion can be accomplished easily. Displacement of all outlets from a pump element is adjustable by a common setting device and features a setting range of 33-100%. The RAB series pump have a pre-assembled oil reservoir.

Features and benefits

- Pump-to-point solution for 1 to 20 lubrication points
- Covers feed rates of certain droplets 36 cm³/min
- Compatible with mineral and synthetic oils
- Vibration-proof, marine and ATEX versions available

Applications

- Gas compressors and large pumps
- General industry, total loss, sealing and small oil-circulation applications
- Marine



NOTE

For further technical information, technical drawings, accessories, spare parts or product function descriptions, see the following publications available on SKF.com/lubrication:

11103 EN, 951-170-230 EN



CAD data

skf-lubrication.partcommunity.com/3d-cad-models/

Technical data

Function principle	radial piston pump with stackable pumping elements, mechanically or electrically operated
Outlets	1 to 20 (max. 5 elements with 1, 2 or 4 outlets)
Metering quantity per outlet	0,007–0,02 cm ³ /revolution 0,0004–0,001 in ³ /revolution
Output per outlet	0,07–36 cm ³ /min 0,004–2,2 in ³ /min
Internal ratio	1:1, 5:1, 10, 5:1, 15:1, 25:1, 75:1, 125:1
Lubricant	mineral- and synthetic-based oil, 25 to 2500 mm ² /s
Reservoir	3, 7, 15 l and more, 0,8, 1,8, 4 gal and more
Operating pressure	10 to 63 bar, 145 to 913 psi depending on drive speed and oil viscosity
Operating temperature	–15 to 80 °C, +5 to 176 °F electrically operated: –15 to 40 °C; +5 to +104 °F
Protection class	min. IP 55
Drive speed	10 to 1 800 min ⁻¹
Connection in/outlet	G 1/8
E-motor drive	with 3-phase motor
Drive direction	left/right
Dimensions	without reservoir: min. 113 × 54 × 54 mm max. 220 × 54 × 54 mm min. 4.45 × 2.13 × 2.13 in max. 8.68 × 2.13 × 2.13 in with reservoir: min. 400 × 333 × 140mm max. 650 × 441 × 288 mm min. 15.7 × 13.1 × 5.5 in max. 25.6 × 17.4 × 11.3 in
Mounting position	any, RAB versions vertical
Options	with manual hand crank for pre-lubrication, customized pre-set volume, reservoir options with further accessories

Pump unit

RA ... M

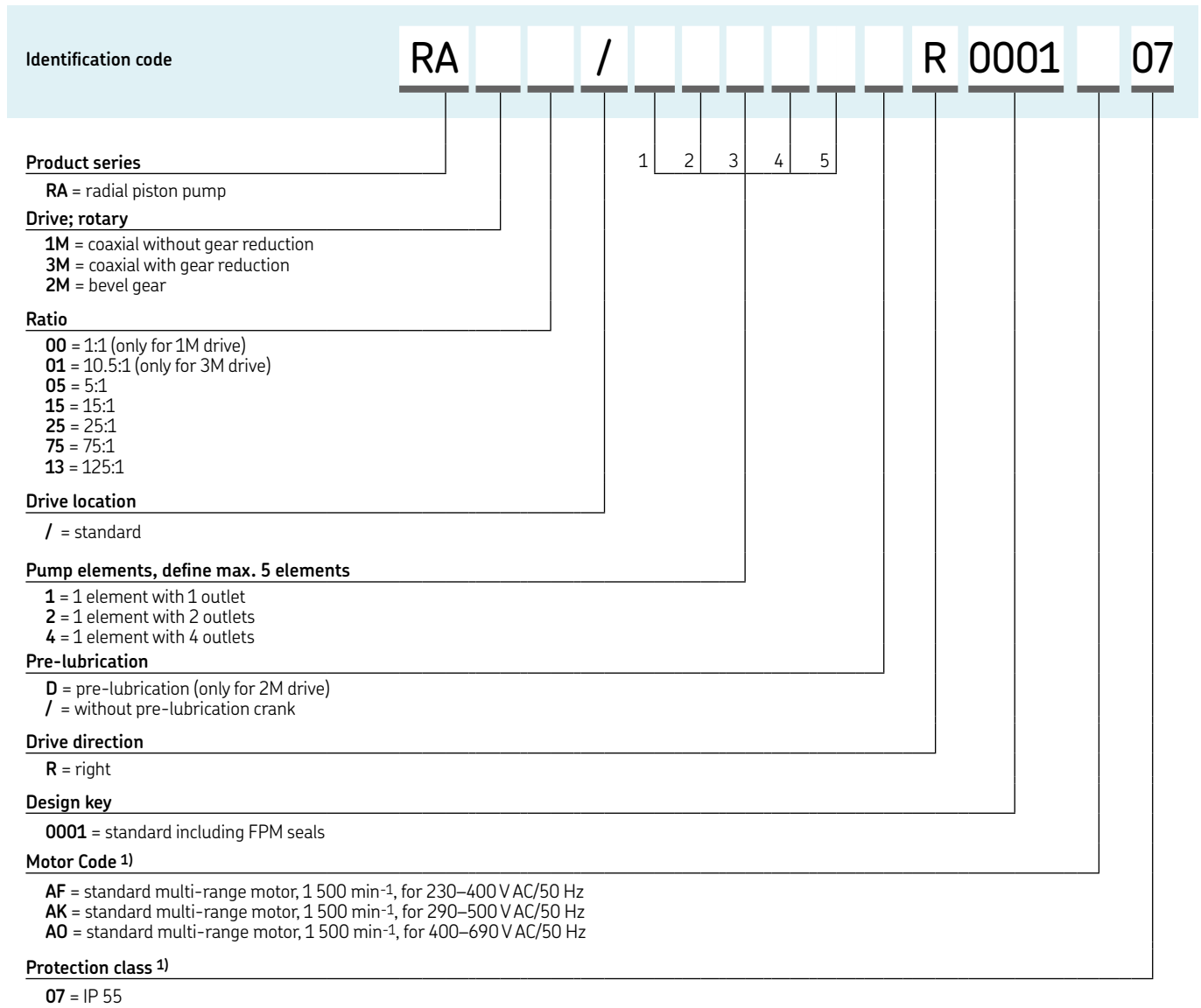

1) further models on request

Pump unit

RAB

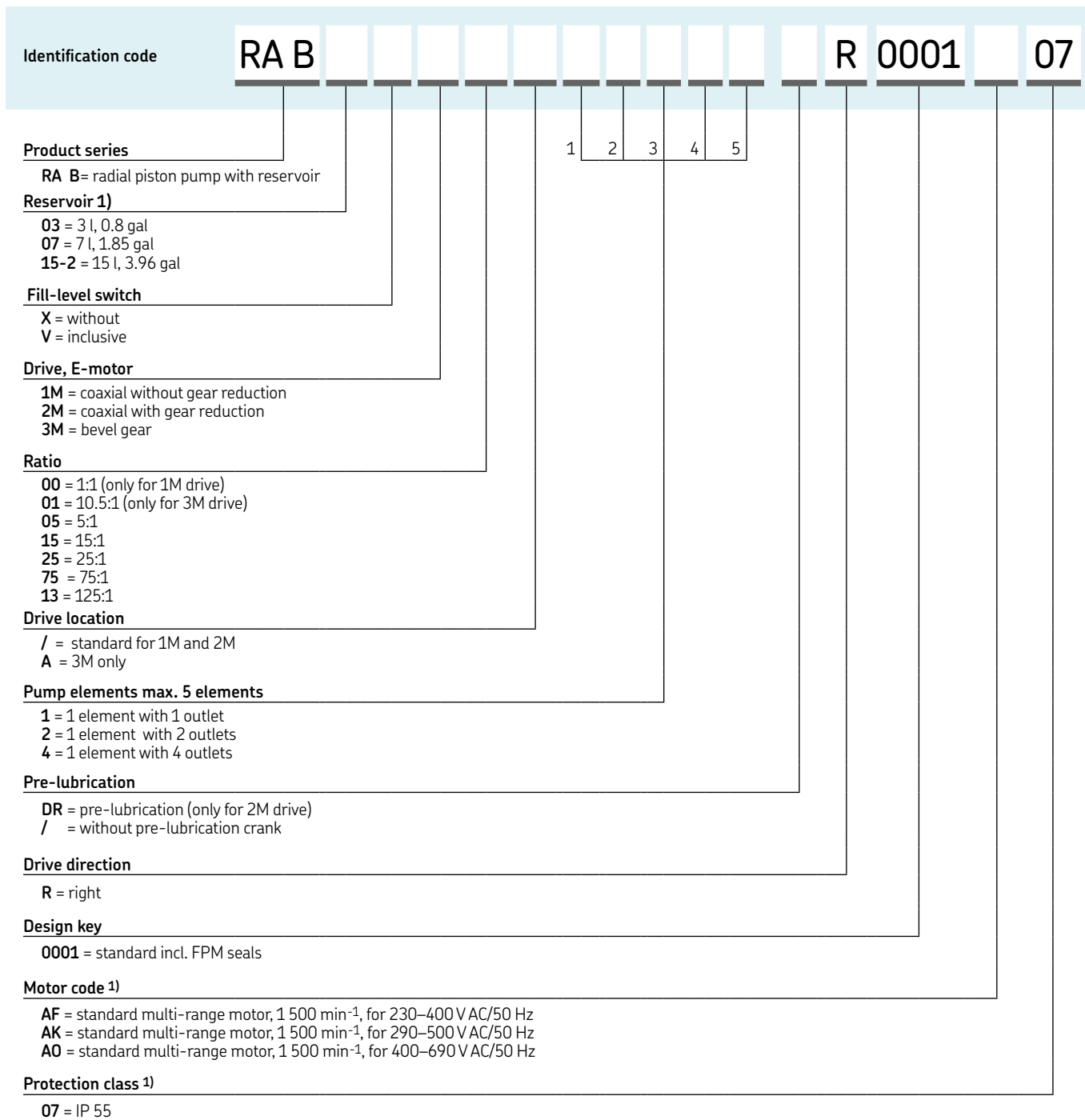

1) further models on request

Pump unit

RA ... accessories

RA ... U drive assembly

Description	Order number
coaxial 1:1	24-0701-3000
coaxial 5:1	24-0701-3070
coaxial 5:1 with pre-lubrication	24-0701-3080
bevel gear, 10,5:1, position A	24-0701-3001
bevel gear, 10,5:1, position B	24-0701-3002
coaxial 15:1	24-0701-3071
coaxial 15:1 with pre-lubrication	24-0701-3081
coaxial 25:1	24-0701-3072
coaxial 25:1 with pre-lubrication	24-0701-3082
coaxial 75:1	24-0701-3073
coaxial 75:1 with pre-lubrication	24-0701-3083
coaxial 125:1	24-0701-3074
coaxial 125:1 with pre-lubrication	24-0701-3084
spacer ring, only oil, for ratio 1:1	24-1721-2000
spacer ring, only grease	24-1721-2001

RA tie rod ¹⁾ for ratio 1:1; 10,5:1; 15:1; 25:1; 75:1

Description	Order number
for 1 pump element	44-0717-2060
for 2 pump elements	44-0717-2061
for 3 pump elements	44-0717-2062
for 4 pump elements	44-0717-2063
for 5 pump elements	44-0717-2064
washer, 6.4 DIN125 ¹⁾	DIN125-B6.4-ST
nut ¹⁾	DIN934-M6-8

RA pump elements for oil and grease

Description	Order number
for 1 outlet	24-1557-3520
for 2 outlets	24-1557-3521
for 4 outlets	24-1557-3522

RA ... M drive assembly

Description	Order number
coaxial 1:1	24-0701-3004
coaxial 5:1	24-0701-3035
coaxial 5:1 with pre-lubrication	24-0701-3036
bevel gear, 10,5:1, position A	24-0701-3003
bevel gear, 10,5:1, position B	24-0701-3004
coaxial 15:1	24-0701-3037
coaxial 15:1 with pre-lubrication	24-0701-3038
coaxial 25:1	24-0701-3039
coaxial 25:1 with pre-lubrication	24-0701-3040
coaxial 75:1	24-0701-3041
coaxial 75:1 with pre-lubrication	24-0701-3042
coaxial 125:1	24-0701-3043
coaxial 125:1 with pre-lubrication	24-0701-3044
spacer ring, only oil, for ratio 1:1	24-1721-2000
spacer ring, only grease	24-1721-2001

RA tie rod ¹⁾ for ratio 5:1; 125:1

Description	Order number
for 1 pump element	44-0717-2069
for 2 pump elements	44-0717-2070
for 3 pump elements	44-0717-2071
for 4 pump elements	44-0717-2072
for 5 pump elements	44-0717-2073
washer, 6.4 DIN125 ¹⁾	DIN125-B6.4-ST
nut ¹⁾	DIN934-M6-8

RA accessories

Description	Order number
cover	24-0413-3490
cap nut	95-0006-0917
hand crank	24-0801-2070

¹⁾ two required per pump

Pump unit

SP/PFE

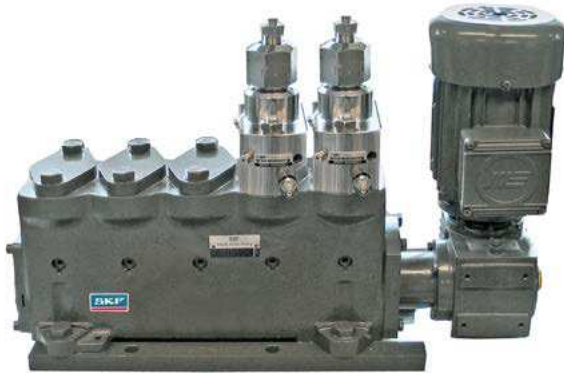

Product description

The SP/PFE multi-line pump is designed for very high system pressures. Its drive parts are located in the pump housing and are pre-filled with high-viscosity gear oil. The special, guided-roller tappet drives the pump element arrangement in a 100% axial direction and eliminates side forces. Each exchangeable pumping element contains a precise, volume-regulating device with scaling, a high-pressure, non-return valve and a high-pressure outlet adapter for up to 4 000 bar (58 000 psi).

Due to the pump's unique design, lubrication oil can be connected from an overhead reservoir directly to the pump elements without the use of additional oil-level controllers.

Features and benefits

- Designed for continuous 24/7 operation
- Modular pump design enables use of up to five pumping elements
- Pressure-tight design; suitable for overhead reservoir connection
- Rack arrangement with additional pumps, filter and flow control equipment available

Applications

- Petro-chemical industry

Technical data

Function principle	Rotary-operated, cam-operated piston pump; with pressure-tight design for overhead reservoirs
Metering quantity per outlet	0–0,14 cm ³ /stroke 0–0.0085 in ³ /stroke
Outlet	1 to 5
Lubricant	mineral- or synthetic-based oil, < 230 mm ² /s
Operating pressure	max. 4 000 bar; 58 000 psi
Operating temperature	+15 to +40 °C, +59 to 104 °F
Internal ratio	1:1
Material	3-phase motor and flanged gearbox available
Drive speed main shaft ¹⁾	10 to 500 min ⁻¹
E-motor drive ¹⁾	10 to 500 min ⁻¹
Connection outlet	gland and sleeve for pipe 3/8 × 1/8
Connection inlet/leak oil outlet	M 14 × 1,5
Dimensions	287 × 350 × 130 cm 512 × 350 × 130 cm 11.3 × 13.8 × 5.1 in 20.15 × 13.8 × 5.1 in
Mounting position	vertical, pump body upright
Options	Available as ATEX package with E-motor drive arrangement, rack mounting, flow monitoring devices

¹⁾ please specify your requirements



NOTE

For further technical information, technical drawings, accessories, spare parts or product function descriptions, see the following publications available on SKF.com/lubrication:

14600EN

Pump unit

SP/PFE

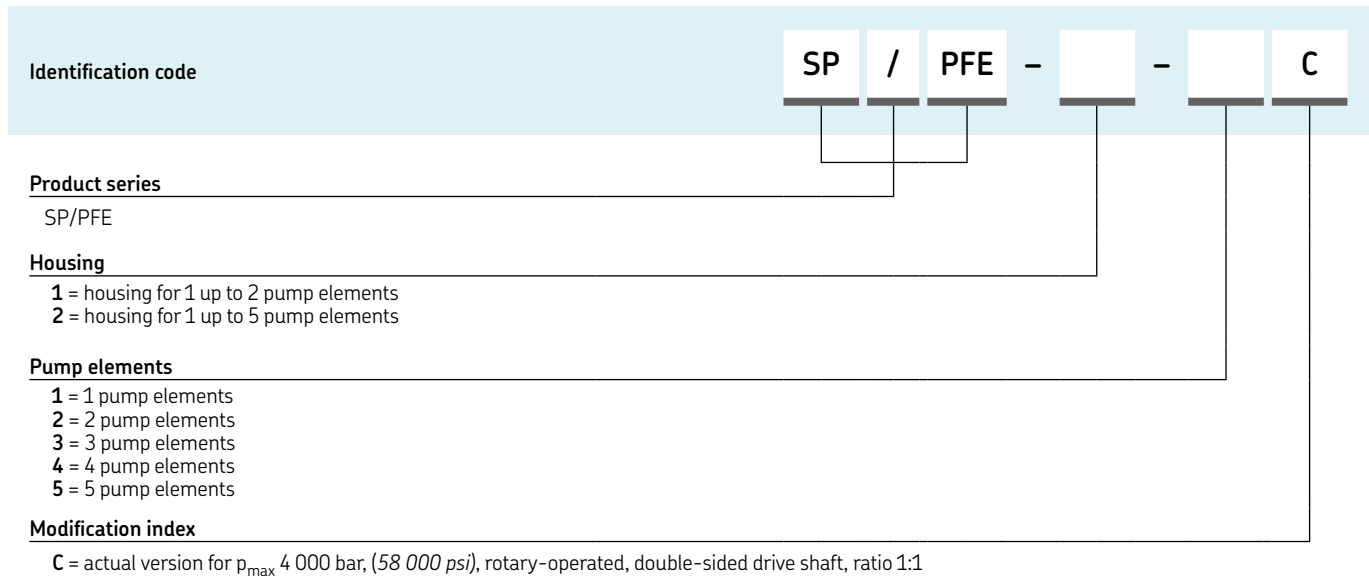

Accessories SP/PFE pump outlets - high-pressure pipe connection required

Dimensions

- 1 = $29^\circ \pm 30'$
- 2 = 3/8 in 24 NF left
- 3 = $\varnothing 5,5$ mm
- 4 = 19 mm

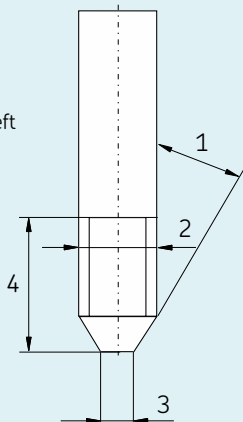

SP/PFE accessories

Order number	Description	Operating pressure max.	
		bar	psi
744-000-0107	high-pressure pump head complete	4 000	58 000
24-2317-2017	high-pressure piston and body only	4 000	58 000



Overview multi-line grease pumps

Hydraulically operated pump units

Product	Lubricant grease NLGI				Outlets	Reservoir ⁶⁾		Metering quantity per outlet		Operating pressure max.		Page
	0	1	2	3		kg	lb	cm ³ /min	in ³ /min	bar	psi	
PFHM-ATEX	•	•	•	–	1–6	6	12	0,80–5,00	0.048–0.305	250	3 625	32

Mechanically operated pump units

Product	Lubricant grease NLGI				Outlets	Reservoir ⁶⁾		Metering quantity per outlet		Operating pressure max.		ATEX ³⁾	Page
	0	1	2	3		kg	lb	cm ³ /min	in ³ /min	bar	psi		
RA 20/45	•	•	•	–	1–12	2–5	4.4–10	0,07–6,00	0.004–0.366	60	870	• ⁴⁾	34
P 205	•	•	•	–	1–5	4–30	8.8–66	0,08–4,20	0.005–0.256	350	5 075	• ⁵⁾	36
FF	•	•	•	•	1–12	4–10	8.8–22	0,04–6,90	0.002–0.421	350	5 075	• ⁴⁾	38
P 215 ²⁾	•	•	•	–	1–15	4–100	8.8–220	0,55–3,15	0.033–0.192	350	5 075	• ⁵⁾	42
FB	•	•	•	•	1–24	6–30	13–66	0,04–7,70	0.002–0.469	350	5 075	• ⁴⁾	44
P 230	•	•	•	–	1–30	30–100	66–220	0,55–3,15	0.033–0.192	350	5 075	•	48

Electrically operated pump units ¹⁾

Product	Lubricant grease NLGI				Outlets	Reservoir ⁶⁾		Metering quantity per outlet		Operating pressure max.		ATEX ³⁾	Page
	0	1	2	3		kg	lb	cm ³ /min	in ³ /min	bar	psi		
RA 20/45	•	•	•	–	1–12	2–5	4.4–10	0,07–6,00	0.004–0.366	60	870	• ⁴⁾	34
P 205	•	•	•	–	1–5	4–30	8.8–66	0,08–4,20	0.005–0.256	350	5 075	• ⁵⁾	36
FF	•	•	•	•	1–12	4–10	8.8–22	0,04–6,00	0.002–0.366	350	5 075	• ⁴⁾	38
P 212 ²⁾	•	•	•	–	1–12	30	66	2,50–25,0	0.152–1.525	350	5 075	•	40
P 215 ²⁾	•	•	•	–	1–15	4–100	8.8–220	0,55–3,15	0.033–0.192	350	5 075	• ⁵⁾	42
FB	•	•	•	•	1–24	6–30	13–66	0,04–7,70	0.002–0.469	350	5 075	• ⁴⁾	44
FB-XL	•	•	•	•	1–16	30	66	0,04–35,0	0.002–2.135	350	5 075	• ⁴⁾	44
P 230	•	•	•	–	1–30	30–100	66–220	0,55–3,15	0.033–0.192	350	5 075	•	48

¹⁾ all data based on 50 Hz operation for connection with a frequency of 60 Hz, the speed and volumetric flow are increased by 20%

²⁾ NLGI 3 on request

³⁾ on request

⁴⁾ for gas: II 2G c IICT4 Gb; for dust: II 2D c IICT 125°C Db

⁵⁾ for gas: II 2G c IICT4 Gb; for dust: II 2D c IICT 120°C Db

⁶⁾ valid for $\rho=1 \text{ kg/dm}^3$

Pump unit

PFHM-ATEX



Product description

The PFHM-ATEX is a hydraulically operated, high-pressure multi-line pump. Its one to six pumping elements are available in five sizes from 0,04 to 0,25 cm³/stroke (0.0024 to 0.0152 in³/stroke) or camshaft revolution. The ratio between the hydraulic motor and camshaft is generally 1:1.

The PFHM-ATEX's sturdy steel housing and reservoir with air breather enable use in dusty areas. When utilized in combination with downstream-located progressive divider valves, it can handle up to approximately 50 lubrication points. The reservoir with stirrer is suitable for both grease and oil and is designed for instead with a locking device.

Features and benefits

- Sturdy design with standard, spring-return pumping elements and ATEX classifications
- Designed for 24/7 operation in harsh environments
- Varying speed and stroke volumes enable economical lubricant settings, hydraulic drive without electrics
- Modular design available in corrosiveness class C3 as standard or C5-M according to DIN EN ISO 12944
- Atex classification for gas, dust and mining application as standard

Applications

- Mining, including underground
- Hydraulically operated machinery
- Screens and crushers in quarries
- Chemical industry, offshore

Technical data

Function principle	hydraulically operated radial piston pump in an ATEX design
Metering quantity per stroke	KFG1.U0: 0,250 cm ³ ; 0.0152 in ³ KFG1.U1: 0,125 cm ³ ; 0.0076 in ³ KFG1.U2: 0,090 cm ³ ; 0.0054 in ³ KFG1.U3: 0,065 cm ³ ; 0.0039 in ³ KFG1.U4: 0,040 cm ³ ; 0.0024 in ³
Metering quantity per outlet	0,8–5,0 cm ³ /min; 0.048–0.305 in ³ /min
Outlets	1 to 6
Lubricant	oil and grease: up to NLGI 2
Operating pressure	max. 250 bar; 3 625 psi
Operating temperature	–20 to +40 °C; –14 to +104 °F
Reservoir ¹⁾	6 kg, 12 lb
Internal ratio	1:1
Drive speed	main shaft 4–30 min ⁻¹
Hydraulic drive oil requirements	51,5 cm ³ per revolution, max. 175 bar, 2 540 psi
Outlet connection lubricant	M 14 × 1,5; tube ø 6, 8, 10 mm
In/outlet hydraulic connection	M 22 × 1,5
Dimensions	580 × 230 × 230 mm 22.8 × 9.1 × 9.1 in
Mounting position	vertical
Options	C5-M

¹⁾ valid for ρ=1 kg/dm³

NOTE

For further technical information, technical drawings, accessories, spare parts or product function descriptions, see the following publication available on SKF.com/lubrication.

Pump unit

PFHM-ATEX

Order information ¹⁾

Order number	Description
PFHM-6-B6-C3-ATEX	standard pump including hydraulic drive, without pumping element version C3 6 kg, 12.6 lbs reservoir; included ATEX approval: gas: II 2G Ex h IIC T6...T5 Gb dust: II 2D Ex h IIC T85°C...T100°C Db mining: I M2
PFHM-6-B6-C5-ATEX	same as above, with an improved corrosion standard C5-M included ATEX approval: gas: II 2G Ex h IIB T6...T5 Gb dust: II 2D Ex h IIC T85°C...T100°C Db mining: I M2

¹⁾ Please order pump elements separately



PFHM-ATEX accessories - pump elements, spring return

Order number C3 version	C5 version	Description	Metering quantity ¹⁾			
			cm ³ /stroke	in ³ /stroke	cm ³ /min	in ³ /min
KFG1.U0	KFG1.U0-C5M	pump element	0,250	0.0152	5,0	0.305
KFG1.U1	KFG1.U1-C5M	pump element	0,125	0.0076	2,5	0.152
KFG1.U2	KFG1.U2-C5M	pump element	0,090	0.0054	1,8	0.109
KFG1.U3	KFG1.U3-C5M	pump element	0,065	0.0039	1,3	0.079
KFG1.U4	KFG1.U4-C5M	pump element	0,040	0.0024	0,8	0.048

¹⁾ The values given are design values of the pump elements and are valid at 20 rpm, a temperature of 20 °C, a back pressure of 50 bar and when using NLGI grade 2 greases.



Pressure regulating valves

Order number C3 version	C5 version	Description	Pipe ø		
			mm	bar	psi
161-210-075	161-210-079	pressure regulating valve	6	250	3 626
161-210-076	161-210-080	pressure regulating valve	8	250	3 626
161-210-077	161-210-081	pressure regulating valve	10	250	3 626

¹⁾ These valves have opening tolerances of ±20%.

Pump unit

RA 20/45



Product description

The RA 20/45 radial piston pump features a modular design that enables use of up to three stackable pump elements, and outlet reduction or extension can be achieved easily.

The displacement of all outlets from a pump element is adjustable by a common setting device with a range of 33 to 100%. The grease reservoir contains a stirrer and screw conveyor to pressurize the grease into the suction chamber. This feature, in combination with a wide range of different selectable gear ratios, enables a small and continuous lubricant flow without the use of extra on/off timers.

Features and benefits

- Modular, pump-to-point solution for 1 to 12 lubrication points
- Suitable for standard NLGI 2 greases
- Grease reservoir for 2 or 4.5 kg (4.4 to 10 lb), optional level switch
- Covers feed rates of droplets up to 10 cm³/min (0.6 in³/min)
- Simple system design with adjustable outputs
- Economical, multi-line grease pump

Applications

- Compact machinery
- Conveyor systems
- Water pumps

Technical data

Function principle	radial piston pump with stackable pumping elements, rotary or electrically operated
Metering quantity per outlet	0,007–0,02 cm ³ /revolution 0,0004–0,0012 in ³ /revolution
Outlets	1 to 12 (max. 3 elements with 1, 2 or 4 outlets)
Lubricant	grease: up to NLGI 2
Operating peak pressure	max. 63 bar, 913 psi
Operating temperature	–15 to +40 °C, +5 to 104 °F
Protection class	IP 55
Reservoir ¹⁾	2,0 or 4,5 kg, 4.4 or 10 lb
Internal ratio	5:1, 10,5:1, 15:1, 25:1, 75:1, 125:1
Drive speed	10 to 245 min ⁻¹
E-motor drive	with 3-phase motor
Outlet connection	G 1/8
Dimensions	depending on the model min. 353 × 180 × 180 mm max. 660 × 325 × 180 mm min. 13.9 × 7.1 × 7.1 in max. 26 × 12.8 × 7.1 in
Mounting position	vertical
Options	with level switch

¹⁾ Valid for $\rho=1 \text{ kg/dm}^3$



NOTE

For further technical information, technical drawings, accessories, spare parts or product function descriptions, see the following publication available on SKF.com/lubrication:

11103 EN, 951-170-230 EN

Pump unit

RA20/45 grease

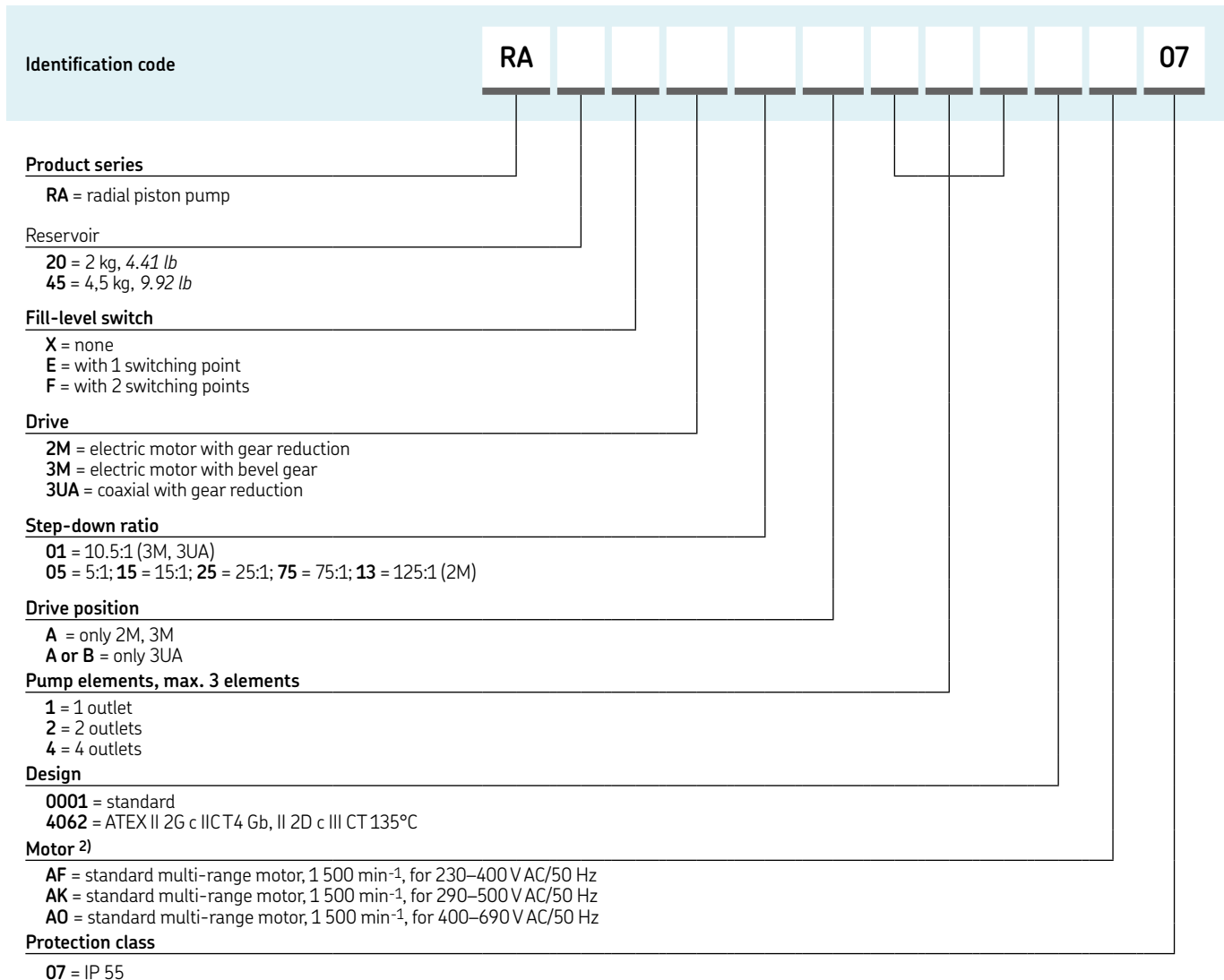

¹⁾ further models on request

RA pump elements and tie rods

Order number	Description
24-1557-3520	pump element for 1 outlet
24-1557-3521	pump element for 2 outlets
24-1557-3522	pump element for 4 outlets
44-0717-2070	tie rod ¹⁾ for 1 pump element
44-0717-2071	tie rod ¹⁾ for 2 pump elements
44-0717-2072	tie rod ¹⁾ for 3 pump elements
DIN125-B6.4-ST	washer, 6.4 DIN125 ¹⁾
DIN934-M6-8	nut ¹⁾

¹⁾ Two required per pump

Reservoirs

Order number	Description
24-0254-2312	reservoir 2 kg, without fill-level switch
24-0254-2334	reservoir 2 kg, with fill-level switch E
24-0254-2330	reservoir 2 kg, with fill-level switch F
24-0254-2310	reservoir 4,5 kg, without fill-level switch
24-0254-2335	reservoir 4,5 kg, with fill-level switch E
24-0254-2331	reservoir 4,5 kg, with fill-level switch F

Pump unit

P 205



Product description

The P 205 high-pressure, multi-line pump can supply lubricant directly to lubrication points or can be used as a centralized lubrication pump in large-sized progressive systems. It can drive up to five elements, which are available in varying sizes for optimum adjustability. The pump's drive and eccentric shaft design, high-efficiency worm gear, minimal number of parts and multi-range motor provide several advantages. P 205 pumps are available with a three-phase flange mount and multi-range motor or with a free shaft end for use with other motors. Various gear ratios and reservoir sizes with or without level control are offered.

Features and benefits

- Durable, versatile and reliable pump series
- Suitable for grease or oil
- Designed for continual lubrication of machines and systems operating in harsh environments
- Broad range of output options
- Modular design and easy maintenance

Applications

- Stationary machines with a high lubricant consumption
- Turbines in hydro-electric power plants
- Needling machines
- Screens and crushers in quarries
- Material handling equipment

Technical data

Function principle	electrically operated, multi-piston pump
Metering quantity per stroke	0,04–0,23 cm ³ 0.002–0.014 in ³
Output per outlet	0,08–4,20 cm ³ /min, 0.005–0.256 in ³ /min
Outlets	1 to 5
Lubricant	oil: viscosity from 40 mm ² /s grease: up to NLGI 2
Operating pressure	max. 350 bar, 5 075 psi
Operating temperature	–20 to +40 °C, –4 to +104 °F
Protection class	IP 55
Materials	steel plate or plastic, depending on reservoir
Reservoir 1)	plastic: 4 and 8 kg, 8.8 and 17.6 lb steel: 5, 10 and 30 kg, 11; 22 and 66 lb
Line connection	G 1/4
Drive speed main shaft	grease: < 25 min ⁻¹ , oil: < 25 min ⁻¹
Electrical connections	380–420 V AC/50 Hz, 440–480 V AC/60 Hz 500 V AC/50Hz
Dimensions	depending on the model min. 406 × 280 × 230 mm max. 507 × 365 × 300 mm min. 160 × 110 × 91 in max. 200 × 144 × 118 in
Mounting position	vertical
Options	several different level switches; ATEX versions

1) valid for $\rho=1 \text{ kg/dm}^3$



NOTE

For further technical information, technical drawings, accessories, spare parts or product function descriptions, see the following publication available on SKF.com/lubrication:

13651 EN

Pump unit

P 205

Identification code: **P 205** - - - - -

Product series

Drive
 M = AC flange gear motor
 F = free shaft end

Gear ratio
 280 = 280:1
 700 = 700:1
 070 = 70:1

Reservoir
 4 = plastic, 4 l, 1.05 gal
 8 = plastic, 8 l, 2.11 gal
 5 = steel plate, 5 l, 1.32 gal
 10 = steel plate, 10 l, 2.64 gal
 30 = steel plate, 30 l, 7.93 gal

Reservoir design
 N = without level control
 XY = for grease and oil
 XL = for grease with low level control
 BU = with level control (ultrasonic sensor for two switching points, low- and high-level)

Pump elements; define max. 5 elements (f.i. 4 elements K6 = 4K6, ...)
 K 5 = piston ø 5 mm, output per stroke: 0,11 cm³, 0.006 in³
 K 6 = piston ø 6 mm, output per stroke: 0,16 cm³, 0.009 in³
 K 7 = piston ø 6 mm, output per stroke: 0,23 cm³, 0.014 in³
 KR = adjustable output, piston ø 7 mm, output per stroke: 0,04-0,18 cm³, 0.002-0.010 in³

Supplements to motor designation
 320 - 420, 440 - 480 = multi-range motor for nominal supply voltage, 380-420 V AC/50 Hz, 440-480 V AC/60 Hz
 500 = single-range motor for nominal supply voltage, 500 V/50 Hz
 000 = pump without motor, with coupling flange

P205 pump elements

Order number	Description	Metering quantity per stroke	
		cm ³	in ³
600-27464-2	pump element piston K 5	0,11	0.006
600-26876-2	pump element piston K 6	0,16	0.009
600-26877-2	pump element piston K 7	0,23	0.014
655-28716-1	pump element adjustable KR (7)	0,04-0,18	0.002-0.010
303-19285-1	closing screw ¹⁾	-	-

¹⁾ for outlet port instead of a pump element

Pressure-relief valve and filling connectors

Order number	Description
624-29056-1	pressure-relief valve, 350 bar, G 1/4 D 6 for tube ø 6 mm OD
624-29054-1	pressure-relief valve, 350 bar, G 1/4 D 8 for tube ø 8 mm OD
304-17571-1	filling connector G 1/4 female ¹⁾
304-17574-1	filling connector G 1/2 female ¹⁾

¹⁾ filling connector fits for vacant outlet ports

Pump unit

FF



Product description

The multi-line pump unit of the FF series is suitable for small- and medium-sized systems due to its flow rate and reservoir. The lubricant can be fed to the lubrication points directly or via a progressive feeder. Designed for use with oil and stiff grease, the FF is a sturdy, vibration-resistant pump that withstands harsh environments and continuous operation.

Features and benefits

- Designed for small- and medium-sized systems
- Sturdy and vibration resistant
- Suitable for oils and very stiff greases
- Withstands harsh operating conditions and continuous operation

Applications

- Automotive industry and wind energy systems
- Construction materials machinery
- Tunnel-driving machinery, mining and conveyor systems
- Paper and boxing machinery
- Steel and heavy industry; annealing machines

Technical data

Function principle	radial piston pump with stirrer, electrically operated
Operating temperature	-15 to +40 °C, +5 to 104 °F
Operating pressure	125 to 350 bar, 1 800 to 5 075 psi
Lubricant	oil: mineral- and synthetic-based; viscosity from 50 mm ² /s grease: up to NLGI 3
Reservoir ¹⁾	4 and 10 kg, 8.8 and 22 lbs
Metering quantity per stroke	KR 6: 0,027–0,08 cm ³ , 0.0016–0.0048 in ³ KR 8: 0,05–0,15 cm ³ , 0.003–0.009 in ³ KR 10: 0,077–0,23 cm ³ , 0.005–0.014 in ³
Internal ratio	33:1, 80:1, 150:1, 300:1, 600:1
Outlet connection	1/4 NPTF, tube ø 6, 8, 10 mm OD
E-motor drive	with 3-phase motor
Drive speed main shaft	< 32 min ⁻¹
Dimensions	min. 450 × 370 × 230 mm max. 656 × 370 × 230 mm min. 17.7 × 14.6 × 9 in max. 25.8 × 14.6 × 9 in
Protection class	IP 55
Mounting position	vertical
Options	several different reservoir designs for oil and grease, level switches, ATEX versions, pressure-limiting valves

¹⁾ valid for ρ=1 kg/dm³



NOTE

For further technical information, technical drawings, accessories, spare parts or product function descriptions, see the following publication available on SKF.com/lubrication:

14129; 951-170-201; 951-180-076

Pump unit

FF

Identification code	FF										A	0001		07
Product series	FF													
Reservoir	04 = 4 kg, 8.81 lb 10 = 10 kg, 22 lb													
Level indicator	X = reservoir without fill-level control/fill-level switch for grease: G = optical fill-level control (dip stick) E = fill-level switch, 1 switching point (min.) F = fill-level switch, 2 switching points (min., max.) H = fill-level switch, 3 switching points (min., min. pre-warning, max.) A = fill-level switch, 3 switching points (min., min. pre-warning, max.) for oil: S = optical fill-level control, sight glass W = read contact, 1 switching point (min.) for grease and oil: U2 = ultrasonic sensor with 2 switching points (min., max.)													
Pump type	1M = motor drive with double gear reduction 2M = motor drive with single gear reduction													
Drive type	1M: 08 = 80:1, 15 = 150:1, 30 = 300:1, 60 = 600:1 2M: 06 = 33:1													
Pump element KR 6 (define in total KR 6, KR 8, KR 120 max. 12 elements)	00-12 = number of pump elements, KR 6 piston \varnothing 6 mm, p_{max} = 350 bar; 5 075 psi													
Pump element KR 8 (define in total KR 6, KR 8, KR 120 max. 12 elements)	00-12 = number of pump elements, KR 8 piston \varnothing 8 mm, p_{max} = 200 bar, 2 900 psi													
Pump element KR 10 (define in total KR 6, KR 8, KR 120 max. 12 elements)	00-12 = number of pump elements, KR 10 piston \varnothing 10 mm; p_{max} = 125 bar; 1 800 psi													
Connection tube \varnothing OD	A = 6 mm B = 8 mm C = 10 mm D = 1/4 NPT- internal thread													
Modification index	A													
Design key	0001 = basic design with adjustable pump elements													
Motor code 1) 2)	AH = 750 min ⁻¹ , for 230–400 V AC/50 Hz AG = 1 000 min ⁻¹ , for 230–400 V AC/50 Hz AM = 750 min ⁻¹ , for 290–500 V AC/50 Hz AL = 1 000 min ⁻¹ , for 290–500 V AC/50 Hz AQ = 1 500 min ⁻¹ , for 400–690 V AC/50 Hz AP = 1 000 min ⁻¹ , for 400–690 V AC/50 Hz AK = 1 500 min ⁻¹ , for 290–500 V AC/50 Hz AF = 1 500 min ⁻¹ , for 230–400 V AC/50 Hz													
Protection class 1)	07 = IP 55, ATEX on request													

1) further models on request

2) 1M = 1 000 + 1 500 min⁻¹; 2M = 750 + 1 000 min⁻¹

Pump unit

P 212



Product description

The P 212 is a high-pressure, multi-line pump that can drive up to 12 elements. It is capable of handling direct supply of lubrication points in multi-line systems or can be used as a centralized lubrication pump in large-sized progressive systems. The drive and eccentric shaft design, high-efficiency worm gear and minimal number of parts provide the pump with several advantages. P 212 pumps are available with a powerful, three-phase, multi-range motor. Suitable for both grease and oil, the reservoir is offered with or without level control.

Features and benefits

- High output per pump element
- High pressure even with difficult lubricants
- Due to the high element output, no element crossporting necessary
- Sturdy and durable pump series that operates in harsh environments
- Modular design
- Easy maintenance

Applications

- Machines with a high lubricant consumption
- Tunnel boring machines
- Mining
- Rubber-mixing machines as a pump for plasticizer liquid



Technical data

Function principle	radial piston pump with stirrer, electrically operated
Outlets	1 to 12
Operating temperature	-20 to +40 °C, -4 to +104 °F
Lubricant	mineral and synthetic oil and grease oil: viscosity from 40 mm ² /s grease: up to NLGI 2
Operating pressure	max. 350 bar, 5 075 psi
Metering quantity per stroke	Piston KR 7: 0,11–0,39 cm ³ ; 0.0067–0.024 in ³ Piston KR 12: 0,33–1,12 cm ³ ; 0.02–0.07 in ³
Reservoir ¹⁾	30 kg, 66 lb
Outlet connection	G 3/8
Internal ratio	67:1
Output per outlet	2,5–25 cm ³ /min, 0.15–1.5 in ³ /min
Drive speed main shaft	< 22 min ⁻¹
E-motor drive	with 3-phase motor
Dimensions	880 × 510 × 350 mm 34.65 × 20.08 × 13.78 in
Protection class	IP 55
Mounting position	vertical



NOTE

For further technical information, technical drawings, accessories, spare parts or product function descriptions, see the following publication available on SKF.com/lubrication:

15301

Pump unit

P 212

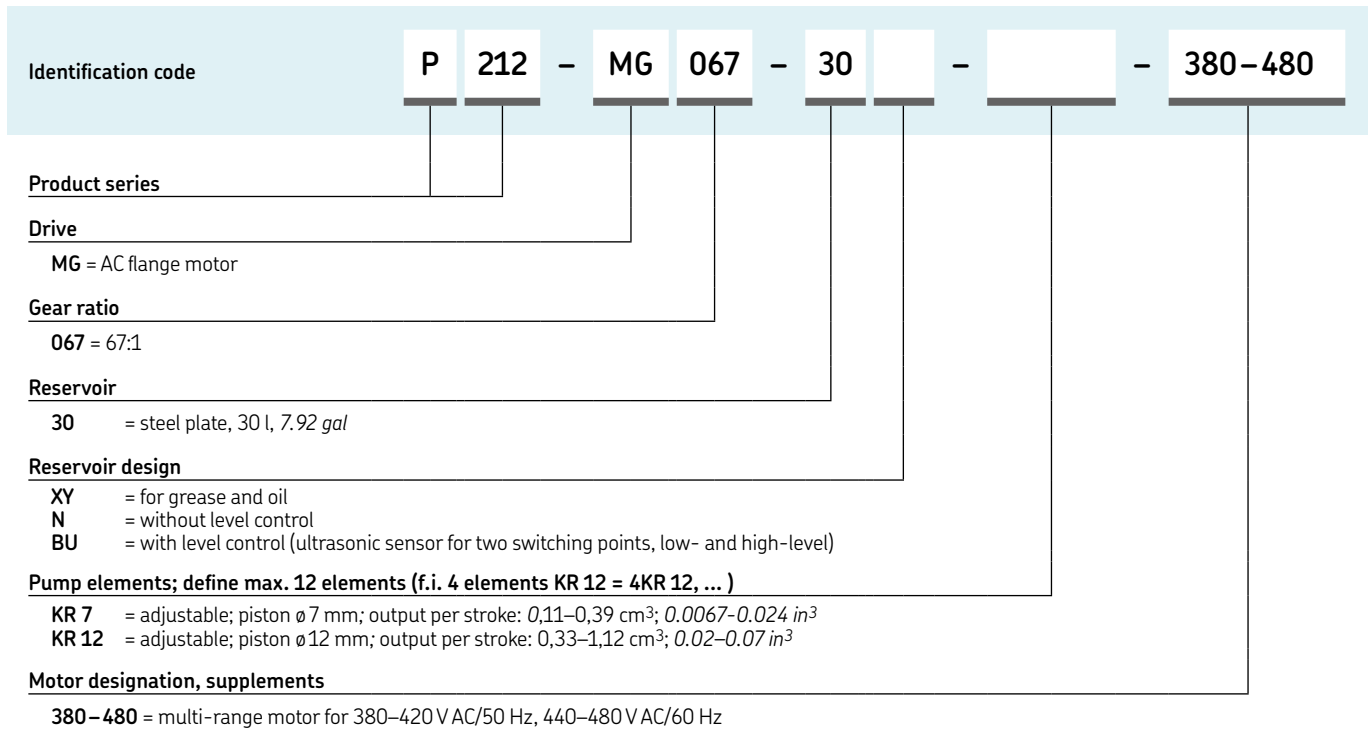

P 212 pump elements and pressure-relief valves

Order number	Description	Connection	Operating pressure max.	
			bar	psi
660-77835-1	pump element KR 7	G 3/8	–	–
660-77619-1	pump element KR 12	G 3/8	–	–
303-17431-1	closing screw ¹⁾	M 27 x 1,5	–	–
624-25483-1	pressure-relief valve ²⁾	tube stud \varnothing 10 mm	350	5 075
624-28362-1	pressure-relief valve ²⁾	tube stud \varnothing 12 mm	350	5 075

¹⁾ for outlet port instead of a pump element

²⁾ to use via T-piece

Pump unit

P 215



Product description

The P 215 is a high-pressure, multi-line pump that can drive up to 15 pump elements. Different sizes of adjustable elements are available. It is capable of handling direct supply of lubrication points or can be used as a centralized lubrication pump in large-sized progressive systems.

P 215 pumps are available with a three-phase, multi-range motor, with a single-range motor, with a free shaft end for use with other motors, or with an oscillating drive. Various gear ratios and reservoirs of different sizes and materials are available. The reservoirs are suitable for both grease and oil and are offered with or without level control.

Features and benefits

- Sturdy and durable pump series
- Continual lubrication of machines and systems that operate in harsh environments
- Versatile pump regarding reservoir and drive types
- Broad range of output possibilities due to high number of outlets and different sizes of pump elements
- Modular design and easy maintenance

Applications

- Stationary machines with a high lubricant consumption
- Screens and crushers in quarries
- Material handling equipment
- Roller coasters

Technical data

Function principle	radial piston pump with stirrer; rotary, oscillating or electrically operated
Outlets	1 to 15
Operating temperature	-20 to +40 °C, -4 to +104 °F
Operating pressure	350 bar, 5 075 psi
Lubricant	mineral and synthetic oil and grease oil: viscosity from 20 mm ² /s grease: up to NLGI 2
Metering quantity per stroke	min. 0,11 cm ³ , 0,0067 in ³ max. 0,23 cm ³ , 0,014 in ³
Reservoir ¹⁾	plastic: 4 and 8 kg, 8.8 and 17.6 lb steel: 10, 30 and 100 kg, 22; 67 and 220 lb
Internal ratio	7:1, 49:1, 100:1, 490:1
Output per Outlet	0,13 to 3,5 cm ³ /min, 0,008 to 0,21 in ³ /min
Outlet connection	G 1/4
E-motor drive	with 3-phase motor
Drive speed	< 28 min ⁻¹
Dimensions	min. 438 × 453 × 326 mm max. 1 225 × 600 × 550 mm min. 17,24 × 17,84 × 12,84 in max. 48,23 × 23,26 × 21,65 in
Protection class	IP 55
Mounting position	vertical
Options	hydraulic driven; 24 V DC motor
¹⁾ valid for ρ=1 kg/dm ³	



NOTE

For further technical information, technical drawings, accessories, spare parts or product function descriptions, see the following publication available on SKF.com/lubrication:

13651 EN

Pump unit

P 215

Identification code	P	215	-				-		-	
Product series	P 215									
Drive	M = AC flange motor F = free shaft end P = oscillating drive									
Gear ratio	490 = 490:1 100 = 100:1 049 = 49:1 (for oil only) 007 = 7:1 (for P and F drive assemblies only)									
Reservoir	4 = plastic, 4 l, 1.05 gal 8 = plastic, 8 l, 2.11 gal 10 = steel plate, 10 l, 2.64 gal	30 = steel plate, 30 l, 7.92 gal 100 = steel plate, 100 l, 26.42 gal								
Reservoir design	YL = for oil with floating-switch, low-level XY = for grease and oil N = without level control BU = with level control (ultrasonic sensor for two switching points, low- and high-level)									
Pump elements, define max. 15 elements (f.i. 11 elements K 7 = 11K7, ...)	1-15 = number of pump elements, adjustable K 5 = piston ø 5 mm, max. adjustable output per stroke: 0,11 cm ³ , 0.0067 in ³ K 6 = piston ø 6 mm, max. adjustable output per stroke: 0,16 cm ³ , 0.0098 in ³ K 7 = piston ø 7 mm, max. adjustable output per stroke: 0,23 cm ³ , 0.014 in ³									
Motor designation, supplements	320-420, 440-480 = multi-range motor for nominal supply voltages, 380-420 VAC/50 Hz, 440-480 VAC/60 Hz 500 = single-range motor for nominal supply voltages, 500 V/50 Hz 000 = pump without motor, with coupling flange									



P215 pump elements and pressure-relief valves

Order number	Description	Connection	Operating pressure max.	
			bar	psi
600-27464-2	pump element K 5	G 1/4	-	-
600-25046-3	pump element K 6	G 1/4	-	-
600-25047-3	pump element K 7	G 1/4	-	-
303-19285-1	closing screw ¹⁾	M 27 x 1,5	-	-
624-25478-1	pressure-relief valve	tube stud ø 6 mm	200	2900
624-25479-1	pressure-relief valve	tube stud ø 6 mm	350	5075
624-25480-1	pressure-relief valve	tube stud ø 8 mm	200	2900
624-25481-1	pressure-relief valve	tube stud ø 8 mm	350	5075
624-25482-1	pressure-relief valve	tube stud ø 10 mm	200	2900
624-25483-1	pressure-relief valve	tube stud ø 10 mm	350	5075
304-17571-1	filler fitting ²⁾	G 1/4 female, M 22 x 1,5	-	-

¹⁾ for outlet port instead of a pump element
²⁾ filling connector fits for vacant outlet ports

Pump unit

FB / FB - XL

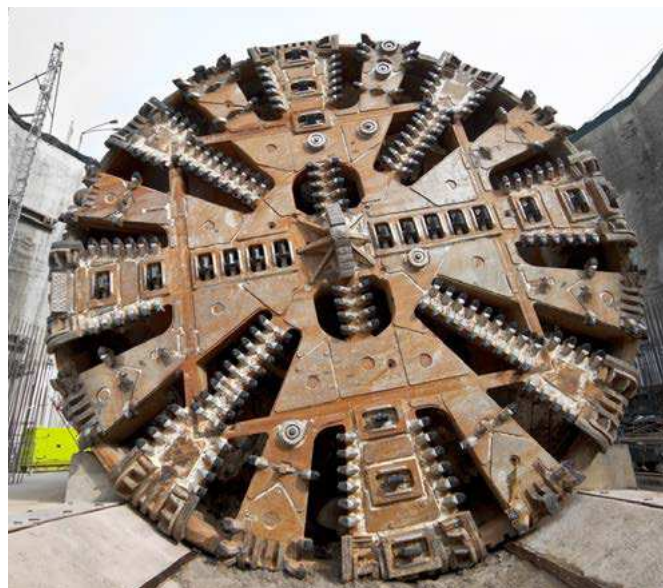

Product description

The FB multi-line pump unit is equipped standard with a motor enclosure of protection class IP 55 or better. The pump is available in a design for explosive atmospheres (ATEX) on request. There are also different fill-level switches for various applications and lubricants. We recommend the U2 ultrasonic design as the standard fill-level switch.

When the FB pump is used as an oil lubrication pump, the reservoir can be equipped with an oil-level monitor and fill-level switch "W". The oil-level monitor is designed and fitted in accordance with the customer's specific requirements as stated when ordering. Additionally, a specialized filling device and a visual fill-level indicator can be installed.

Features and benefits

- Sturdy, vibration-resistant multi-line pump
- Suitable for oil and very stiff greases
- Withstands harsh operating conditions and continuous operation
- Suitable for large systems
- Lubricant can be fed directly to lubrication points or via progressive feeder system

Applications

- Automotive industry and wind energy systems
- Construction materials machinery
- Tunnel-boring and mining, conveyor systems
- Paper and packaging machinery
- Steel and heavy industry

Technical data

Function principle	radial piston pump with stirrer
Operating temperature	-15 to +40 °C, +5 to 104 °F
Operating pressure	125 to 350 bar, 1 800 to 5 075 psi
Outlets	1-24
Lubricant	oil: viscosity from 40 mm ² /s grease: up to NLGI 3
Metering quantity per stroke	
KR 6:	0,027-0,08 cm ³ , 0,0016-0,0048 in ³
KR 8:	0,050-0,15 cm ³ , 0,0030-0,0091 in ³
KR 10:	0,077-0,23 cm ³ , 0,0047-0,0140 in ³
for FB-XL lower level KR 7:	0,11 - 0,39 cm ³ , 0,0067-0,0237 in ³
for FB-XL lower level KR 12:	0,33-1,12 cm ³ , 0,020-0,068 in ³
Reservoir ¹⁾	6, 15, 30 kg, 13.2, 33, 66 lb
Outlet connection	1/4 NPTF, tube ø 6, 8, 10 mm OD
Internal ratio	45:1, 105:1, 288:1, 720:1
Output per outlet	0,04-7,7 cm ³ /min 0,0024-0,47 in ³ /min
Drive speed main shaft	< 32 min ⁻¹
E-motor drive	with 3-phase motor
Dimensions	min. 420 × 533 × 290 mm max. 660 × 533 × 290 mm min. 16.5 × 26 × 11.4 in max. 26 × 26 × 11.4 in
Protection class	IP 55
Mounting position	vertical
Options	ATEX versions, safety valves

¹⁾ valid for ρ=1 kg/dm³

NOTE

For further technical information, technical drawings, accessories, spare parts or product function descriptions, see the following publication available on SKF.com/lubrication:
1-3026; 951-170-21; 951-170-201;
951-170-227; 951-180-076

Pump unit

FB

Identification code	FB												A	0001			07
Product series	FB																
Reservoir	06 = 6 kg, 13 lb 15 = 15 kg, 33 lb 30 = 30 kg, 66 lb																
Level indicator	X = without for grease: G = visual indicator for grease (dip stick) E = min. level, 1 switching point, 230 V AC/DC F = min./max. level, 2 switching points, 42 V AC/DC H = min., pre-warning min., max. level, 3 switching points, 30 V DC A = min., pre-warning min., max. level, 3 switching points, 250 V AC/DC J = min./max. level and pre-warning, 4 switching points, 30 V DC for oil: S = visual indicator for oil (sight glass) W = float switch for oil, min. level, 1 switching point, 250 V AC/DC for grease and oil: U2 = ultrasonic sensor for oil/grease, min./max. level, 2 switching points, 30 V AC/DC																
Drive type	1M = motor drive with double gear reduction 2M = motor drive with single gear reduction																
Ratio internal	1M drive : 06 = 105:1 07 = 288:1 08 = 720:1 2M drive: 04 = 45:1																
Drive position	1M drive: B = reservoir: 6, 15 and 30 kg; 13, 33, 66 lb E = reservoir: only 6 and 15 kg; 13, 33 lb 2M drive: H = reservoir: 6, 15 and 30 kg; 13, 33, 66 lb																
Pump elements ø 6 mm (define in total max. 24)	00–24 = number of pump elements, piston ø 6 mm; $p_{max} = 350 \text{ bar}$; 5 075 psi																
Pump elements ø 8 mm (define in total max. 24)	00–24 = number of pump elements, piston ø 8 mm; $p_{max} = 200 \text{ bar}$, 2 900 psi																
Pump elements ø 10 mm (define in total max. 24)	00–24 = number of pump elements, piston ø 10 mm; $p_{max} = 125 \text{ bar}$; 1 800 psi																
Connection tube ø OD	A = 6 mm C = 10 mm B = 8 mm D = 1/4 NPT– internal thread																
Modification index	A = actual version																
Design key	0001 = standard																
Motor code ¹⁾	AG = 1 000 min ⁻¹ , for 230–400 V AC/50 Hz AF = 1 500 min ⁻¹ , for 230–400 V AC/50 Hz AL = 1 000 min ⁻¹ , for 290–500 V AC/50 Hz AK = 1 500 min ⁻¹ , for 290–500 V AC/50 Hz AP = 1 000 min ⁻¹ , for 400–690 V AC/50 Hz AO = 1 500 min ⁻¹ , for 400–690 V AC/50 Hz																
Protection class ¹⁾	07 = IP 55, ATEX on request																

¹⁾ other models on request

Pump unit

FB - XL

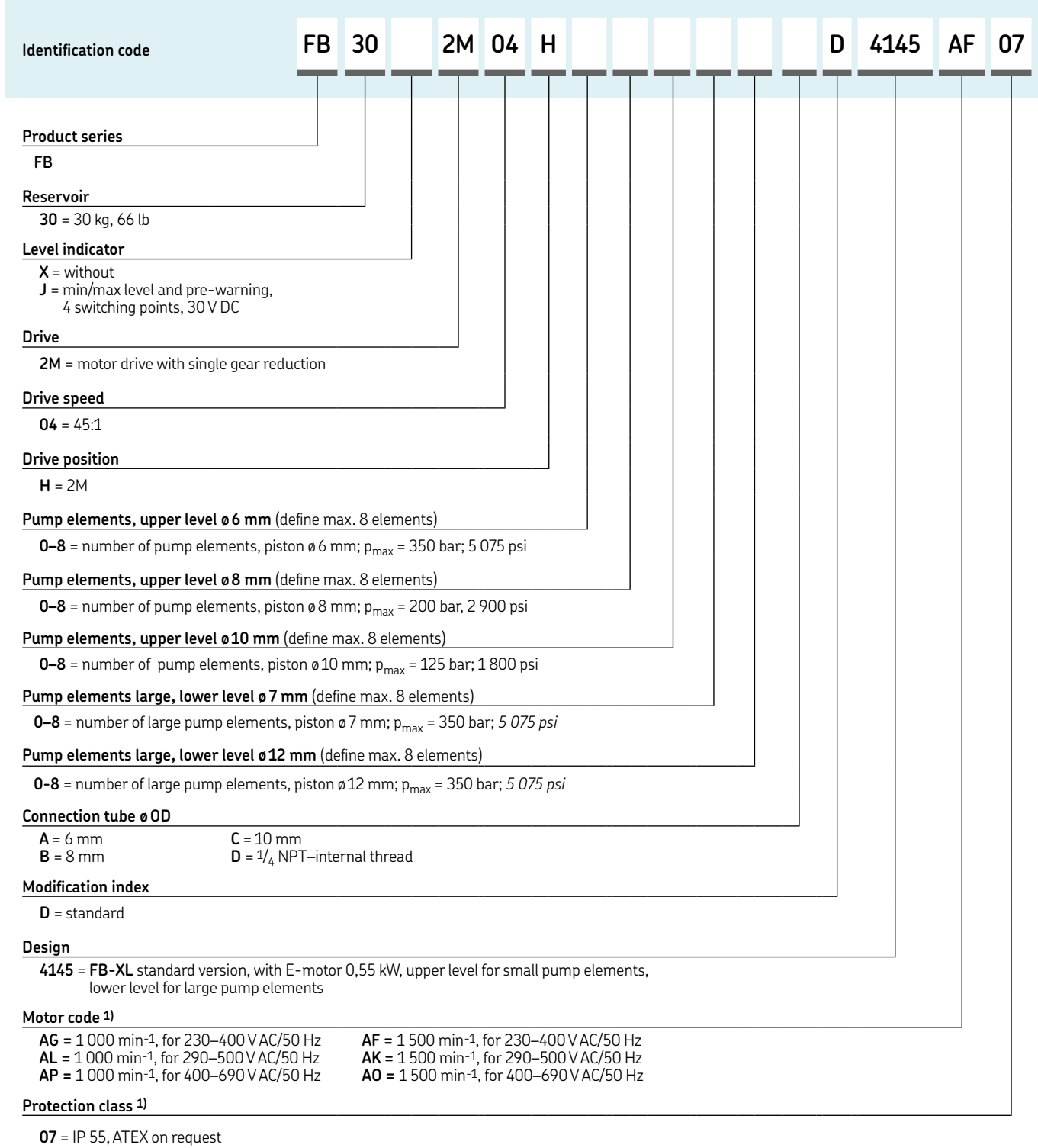

¹⁾ Other models on request

Pump unit

FB/FB - XL/FF Accessories



Pump elements for oil and grease FF, FB and FB-XL upper level

Order number	Piston
	ø mm
24-1557-3680	6
24-1557-3681	8
24-1557-3683	10

Pump element for oil and grease, FB-XL lower level, P 212 ¹⁾

Order number	Piston
	ø mm
660-77835-1	7
660-77619-1	12

¹⁾ pressure-limiting valve see chapter valves

Pressure-limiting valves for grease pump elements FF, FB and FB-XL upper level ¹⁾

Order number	Pressure	
	bar	psi
24-2103-2273	50	725
24-2103-2344	100	1 450
24-2103-2345	125	1 815
24-2103-2342	150	2 175
24-2103-2272	175	2 540
24-2103-2346	200	2 900
24-2103-2271	350	5 075

¹⁾ for direct assembly for each pump element (instead of the closure plug)

Outlet stud

Order number	Tube
	ø mm
24-2255-2003	6
24-2255-2004	8
24-2255-2005	10

Pump unit

P 230



Product description

A derivative of the P 215 pump, the P 230 is a high-pressure, multi-line pump that can drive up to 30 adjustable pump elements. It is used within a multi-line system to directly supply lubrication points or within large-sized progressive systems. Due to the increased number of possible pump elements compared to the P 215, a powerful 0,25kW motor is used.

P 230 pumps are available with a three-phase, multi-range motor or a single-range motor, and various gear ratios are offered. Suitable for grease or oil, reservoirs are available in different sizes with or without level control.

Features and benefits

- Sturdy and durable pump series
- Continual lubrication of machines and systems that operate in harsh environments
- Broad range of output options due to increased number of outlets and varying sizes of adjustable pump elements
- Modular design and easy maintenance

Applications

- Stationary machines with high lubricant consumption
- Rubber- and plastic-mixing machines
- Conveyors
- Cranes
- Eccentric presses
- Forging machines



Technical data

Function principle	radial piston pump with stirrer, rotary, oscillating or electrically operated
Outlets	1 to 30
Operating temperature	-20 to +40 °C, -4 to +104 °F
Lubricant	mineral and synthetic oil and grease oil: viscosity from 20 mm ² /s grease: up to NLGI 2
Operating pressure	max. 350 bar, 5 075 psi
Metreing quantity per stroke	min. 0,11 cm ³ , 0.0067 in ³ max. 0,23 cm ³ , 0.014 in ³
Reservoir ¹⁾	30 and 100 kg, 66 and 220 lb
Internal ratio	7:1, 49:1, 100:1, 490:1
Output per outlet	0,13–6,4 cm ³ /min, 0.008–0.39 in ³ /min
Outlet connection	G 1/4
E-motor drive	with 3-phase motor
Drive speed	< 28 min ⁻¹
Dimensions	min. 840 × 463 × 330 mm max. 1300 × 463 × 550 mm min. 33.07 × 18.23 × 12.99 in max. 51.18 × 18.23 × 21.65 in
Options	hydraulic drive; 24 V DC motor

¹⁾ valid for $\rho=1 \text{ kg/dm}^3$



NOTE

For further technical information, technical drawings, accessories, spare parts or product function descriptions, see SKF.com/lubrication.

Pump unit

P 230

Identification code: **P 230** - - - - -

Product series

Drive
 MG = AC flange gear motor
 F = free shaft end

Gear ratio
 490 = 490:1
 100 = 100:1
 049 = 49:1 (for oil only)

Reservoir
 30 = steel plate, 30 l, 7.92 gal
 100 = steel plate, 100 l, 26.42 gal

Reservoir design
 YL = for oil with floating-switch low level
 XY = for grease and oil
 N = without level control
 BU = with level control (ultrasonic sensor for two switching points, low- and high-level)

Pump elements, adjustable, define max. 30 elements (f.i. 25 elements K6 = 25K6, ...)
 1-30 = number of pump elements
 K 5 = piston ø 5 mm, max. adjustable output per stroke: 0,11 cm³, 0.0067 in³
 K 6 = piston ø 6 mm, 0.236 in, max. adjustable output per stroke: 0,16 cm³, 0.0098 in³
 K 7 = piston ø 7 mm, 0.275 in, max. adjustable output per stroke: 0,23 cm³, 0.014 in³

Supplements to motor designation
 320-420, 440-480 = multi-range motor for nominal supply voltages, 380-420 V AC/50 Hz, 440-480 V AC/60 Hz
 500 = single-range motor for nominal supply voltages, 500 V AC/50 Hz
 000 = pump without motor, with coupling flange



P 230 pump elements and pressure-relief valves

Order number	Description	Connection	Pressure max	
			bar	psi
600-27464-2	pump element K 5	G 1/4	-	-
600-25047-3	pump element K 7	G 1/4	-	-
600-25046-3	pump element K 6	G 1/4	-	-
303-19285-1	closing screw ¹⁾	M 27 x 1,5	-	-
624-25478-1	pressure-relief valve	tube stud ø 6 mm	200	2 900
624-25479-1	pressure-relief valve	tube stud ø 6 mm	350	5 075
624-25480-1	pressure-relief valve	tube stud ø 8 mm	200	2 900
624-25481-1	pressure-relief valve	tube stud ø 8 mm	350	5 075
624-25482-1	pressure-relief valve	tube stud ø 10 mm	200	2 900
624-25483-1	pressure-relief valve	tube stud ø 10 mm	350	5 075
304-17571-1	filler adapter	G 1/4 female ²⁾	-	-
304-17574-1	filler adapter	G 1/4 female ²⁾	-	-

¹⁾ for outlet port instead of a pump element
²⁾ filling connector fits for vacant outlet ports



Overview of control units

Manually operated pumps									
Product	Description 1)	Voltage		Timer	Level monitoring	Pulse evaluation	Without housing	Stand alone	Page
		VAC	VDC						
IGZ ...	only for one pump	115–230	24	•	•	–	•	–	52
EXZT ...	for one pump and one pulse generator	115–230	24	•	•	•	•	–	52
EOT-2	only for one pump	–	12, 24	•	–	–	–	•	54
LMC 2	for one pump and one pulse generator	230	24	•	•	•	–	•	55
LMC 301	. six pulse generators (with extension 10 extra)	90–264	24	•	•	•	–	•	56
					•	•			

IGZ/EXZT



Product description

IGZ 51 and EXZT universal electronic control and monitoring devices are used in multi-line and progressive lubrication systems and are available in two voltage versions. Developed for stationary industrial applications, these devices may be installed in a switching cabinet or internally in a compact lubrication unit. They can be used as time-dependent or pulse-dependent controllers to initiate a lubrication cycle.

The EXZT devices control the pump running time and monitors simultaneously the strokes of the pulse generator or sensor of the metering device. All devices have custom-built functions integrated and can be set to meet system requirements.

Features and benefits

- Combined universal control and monitoring device
- Easy installation by top hat rail mounting
- Adjustable operating modes
- Time operation or load-dependent, machine-stroke operation
- Low-level control and EPROM included

Applications

- Stationary industrial applications
- Installation in switching cabinet of stationary general industry machines

Technical data

Function principle	universal electronic control and monitoring device
Operating temperature	0 to +60 °C, +32 to 140 °F
Output voltage	24 V DC +10%/-15%
Connector for class	II
Protection class	IP 30, clamps IP 20
Dimensions	70 × 75 × 110 mm 2.7 × 3 × 4.3 in

Version + 471

Input voltage	100 – 120 V AC; 200 – 240 V AC
Input current rated	70 mA / 35 mA
Power input	8 W
Frequency	50 – 60 Hz
Fuse	max. 6.3 A
Switching current	max. 5 A
Input voltage sensors	24 V DC

Version + 472

Input voltage	20 – 24 V DC; 20 – 24 V AC
Input current rated	75 mA at max. fan-out of 250 mA
Power input	5 W
Frequency	DC or 50 – 60 Hz
Fuse	max. 6.3 A
Switching current	max. 5 A
Input voltage sensors	24 V DC



NOTE

For further technical information, technical drawings, accessories, spare parts or product function descriptions, see the following publications available on SKF.com/lubrication:

1-1700-1 EN, 1-1700-2 EN, 951-180-001 EN

Control unit

IGZ/EXZT

Order information

Order number	Input voltage	Monitoring time adjustable	Level monitoring	Interval time extension	Lubricant levels early warning, contact	Pulse monitoring
IG351-10-E + 471	120, 230 V AC	•	NO ³⁾	•	–	–
IG351-10-E + 472	24 V DC	•	NO ³⁾	•	–	–
EXZT 2A03-E + 471	120, 230 V AC	•	NC ⁴⁾	•	•	•
EXZT 2A03-E + 472	24 V DC	•	NC ⁴⁾	•	•	•

¹⁾ Only for one pump

²⁾ For one pump and one pulse transmitter

³⁾ NO = contact normally open

⁴⁾ NC = contact normally closed

Control unit

EOT - 2



Product description

The EOT-2 controller is designed to control lubrication pumps during interval operation in multi-line systems. Rotary switches on the printed circuit board may be used to adjust lubrication time in seconds or minutes and pause time in minutes or hours. The EOT-2 is suitable for retrofit installation and often is used when a lubrication pump has no integrated control unit. Additional lubrication cycles can be triggered via a pushbutton.

Features and benefits

- Easy-to-use controller for installation, indoor and outdoor
- Suitable for retrofit, easy time setting and function control

Applications

- Lubrication pumps without integrated controller
- Agricultural machinery, chain lubrication systems
- Simple lubrication systems in machines
- In connection with motor relay assembly; also preferred for three-phase, multi-line pump units

Technical data

Function principle	control and monitoring device
Operating temperature	-25 to +70 °C, -13 to +158 °F
Supply voltage	12 or 24 V DC
Current draw	max. ≤ 7 A
Outputs	transistor / N.O.
Pause time	min. 4 min max. 15 h
Running time	min. 8 sec max. 30 min
Standard	CE
Protection class	IP 65
Dimensions	122 × 118 × 56 mm, 4.80 × 4.65 × 2.00 in
Mounting position	any

Order information

Order number	Description
236-10850-7	EOT-2 controller with motor starter 0,4-0,6 A
236-10850-8	EOT-2 controller with motor starter 0,6-1,0 A
236-10850-9	EOT-2 controller with motor starter 1,0-1,6 A
236-10980-6	EOT-2 controller with motor starter 2,4-4,0 A
664-34135-7	EOT-2 controller, for one pump only



NOTE

For further technical information, technical drawings, accessories, spare parts or product function descriptions, see the following publication available on SKF.com/lubrication:

16966 EN, 951-170-232

Control unit

LMC2



Product description

The LMC 2 is a controller for the electronic management and monitoring of lubrication systems. It combines the advantages of a specially developed printed circuit board (PCB) and a PLC in an economical, compact unit. For progressive systems, it controls the pump unit and the metering devices.

Features and benefits

- Integrated, flexible lubrication programs
- 8 inputs / 5 outputs; suitable for complex lubrication systems
- Time- or cycle-dependent control of lubrication intervals
- Can be interfaced with common field bus systems

Applications

- General lubrication systems with a pump and pulse generator
- Railway
- Food and beverage
- ChaLMCin lubrication systems like Lincoln Cobra and PMA
- Multi-line as well as dual-line, single-line and progressive systems

Technical data

Function principle	control and monitoring device
Operating temperature	-10 to +70 °C, -14 to +158 °F
Supply voltage	12 or 24 V DC
Inputs	max. 8 digital inputs
Outputs	4 relay outputs, 1 electronic
Operating voltage	depending on model: 230 V AC, 24 V DC (± 10%)
Standard	CE
Protection class	IP 54
Dimensions	200 × 120 × 90 mm, 7.9 × 4.7 × 3.5 in
Mounting position	any

Order information

Order number	Description
--------------	-------------

236-10567-6	LMC 2; 230 AC (230 V AC)
--------------------	--------------------------

236-10567-5	LMC 2; 24 DC (24 V DC)
--------------------	------------------------

For use with electrically operated 3-phase pump must order motor starter separately.

NOTE

For further technical information, technical drawings, accessories, spare parts or product function descriptions, see the following publication available on SKF.com/lubrication:

14004 EN

Control unit

LMC 301



Product description

The LMC 301 is a compact, modularly expandable control and monitoring device. It is equipped with an LCD display and six functional keys for programming, parameter setting and signalization. The user is guided through the setup menu. Additionally, there is offered a simple-to-use PC software for parameter setting and diagnostics.

Features and benefits

- Integrated, flexible lubrication programs
- Main device with 10 digital inputs, for 3 lubrication pumps and max. 6 pulse transmitters
- Up to 7 slave/extension modules can be added with additional inputs for max. 10 pulse transmitters
- Three lubrication pumps can be controlled and monitored

Applications

- General and heavy industry
- Mining – stationary and mobile excavators
- Multi-, dual-, single-line and progressive systems

Technical data

Function principle	Control and monitoring device
Operating temperature	VAC: -10 to + 50 °C; +14 to 122 °F VDC: -40 to +70°C; -40 to 158 °F
Inputs	10 count, short-circuit proof, 2 with analog
Outputs	8 count, relay outputs NO-contact 8 A, 2 of which up to 15 A
Operating voltage	depending in model 100-240 VAC, 24 VDC ±20%
Standard	CE; UL; CSA
Protection class	IP 65
Dimensions	270 × 170 × 90 mm 10.7 × 6.7 × 3.5 in
Mounting position	vertical

Order information

Order number	Designation
--------------	-------------

086500	LMC 301; 24 V DC, master
086501	LMC 301; 100-240 V AC, master
086502	LMC 301; 24 V DC, I/O board, slave
086503	LMC 301; 100-240 AC, I/O board, slave



NOTE

For further technical information, technical drawings, accessories, spare parts or product function descriptions, see the following publications available on SKF.com/lubrication:

15967 EN, 951-150-029 EN

LMC 301 - Accessories



LMC 301 motor relay assembly

Order number	Description
236-10850-7	with motor starter 0,4–0,6 A
236-10850-8	with motor starter 0,6–1,0 A
236-10850-9	with motor starter 1,0–1,6 A
236-10980-6	with motor starter 2,4–4,0 A

LMC 301 housing

Order number	Description
086504	door housing, complete
086505	cable USB

Order numbers

Order number	Description
086506 086507	PG-M20 Cable gland kit, IP 65 Multiple cable gasket set (3 x) Cable gasket set (3 x)
3515-10-6020 3515-10-6620	Cable glands PG-M20; complete, with cap nut, cable gasket set (2), screw plug cartridge (3) Cable gasket set (2); 2-wire, ø 0.24 in Cable gasket set (2); 4-wire, ø 0.2 in
3515-10-7620 3515-10-6220 3515-10-6320	Blind plug Gasket Counter nut
3515-07-6120 3515-10-2021 3515-07-2022 179-990-486 236-11066-1	Conduit glands, IP 65, with flexible metal tube (FMC), UL approved Conduit glands AMG-M 20 x 1,5; UL 514B Counter nut M 20 x 1,5 Protection hose, liquid-proof protective; UL 360 (sold by the metre, when ordering specify the required length) Fuse, blade-type, FK1 3A (32 V) according to ISO 8820-3 Battery, 3 V lithium button cell, model CR3032
www.skf.com/LMC301	LMC 301 software, free download

¹⁾ The installation of the cable glands and cable sets to be provided and done by the customer. The customer is responsible for proper installation.



Overview of monitoring devices

Product finder							
Product	Function type	Description	Voltage		Without housing	Stand alone	Page
			VAC	VDC			
SP/SFE 30/5	pulse generator	standard version	0 - 30	0 - 30	–	•	60
SP/SFE 30/6 GL	pulse generator	GL approved	0 - 30	0 - 30	–	•	60
SP/SFE 30/3003	pulse generator	ATEX II2G .. and II2D ..	0 - 30	0 - 30	–	•	60
EWT2A	pulse monitor	for up to 3 pulse generators	115, 230	24	•	–	61
234-11145-3/4/5/9	digital pressure switch	pressure switch for extensive lubrication point monitoring	–	18–36	–	•	62
234-10825-8	digital pressure switch	pressure switch for simple lubrication point monitoring	125, 250	30–250	–	•	63

Monitoring devices

SP/SFE 30



Product description

SP/SFE30 pulse generators are designed to monitor oil and grease volumetric flow rates. The switching pulses are generated at a rate proportional to the volumetric flow, and the pulses from the pulse generator are evaluated by a downstream control unit. SP/SFE30/6GL pulse generators have been approved by German Lloyd for use on ships. Explosion proofed versions (SP/SFE 30/3003 ATEX) for gas and dust are available as well.

Features and benefits

- For oil and grease up to NLGI 2
- Operating pressure of up to 600 bar (8 700 psi)
- Germanischer Lloyd-approved device available

Applications

- For small lubricant flow measurements, in general
- Reciprocating compressors
- Oil and gas industry
- Marine

NOTE

 For further technical information, technical drawings, accessories, spare parts or product function descriptions, see the following publications available on SKF.com/lubrication:

1-3009 EN, 1-3018 EN; 951-230-012 EN

Technical data

Function principle	pulse generator based on a progressive metering principle
Operating temperature	-15 to +70 °C; +5 to 158 °F
Operating pressure	4 to 600 bar; 58 to 8 700 psi
Lubricant	oil min. viscosity 12 mm ² /s
Volumetric flow range	grease up to NLGI 2
Volume/pulse ¹⁾	0,1–50 cm ³ /min; 0.0061–3.0512 in ³ /min
Contact type	reed contact
Connection	SP/SFE 30/5: plug DIN 43650
Switching voltage	SP/SFE 30/6 GL: cable 2 m, 6.56 ft
Switching capacity	0 to 30 V AC/V DC
Standard	10 W with V AC/V DC
Protection class	CE, GL (Germanischer Lloyd)
Dimensions	IP 67
	65 × 170 × 35 mm; 2.56 × 6.69 × 1.37 in

¹⁾ One pulse comprises the opening or closing of the reed contact. Volume/cycle = 0,68 cm³ when a pulse monitoring unit is used (opening until reopening or closing to reclosing of reed contact).

Order information

Order number	Designation
--------------	-------------

24-2583-2516	SP/SFE 30/5
24-2583-2517	SP/SFE 30/6 GL
	SP/SFE 30/3003
24-2583-2526	ATEX II2G ... and ATEX II2D ...

SP/SFE 30 accessories

Order number	Description
--------------	-------------

406-411	straight connector G 1/4 for ø 6 mm tube
96-1108-0058	straight connector G 1/4 for ø 8 mm tube

EWT2A



Product description

The EWT2A series of universal pulse monitoring devices can be used in all standard SKF lubrication systems. The pulse, generated from a progressive metering valve sensor, a pulse generator or a rotary gear sensor, must be received within a pre-selected and defined value. Depending on the selected version, a minimum and a maximum value can be monitored simultaneously for two or three pulse inputs. The EWT2A pulse monitoring devices are available in two voltage versions and may be installed in a switching cabinet. All devices have custom-built functions integrated and can be set to meet system requirements.

Features and benefits

- Easy installation by top hat rail mounting
- Adjustable operating modes
- Monitoring time 6–90 seconds
- Settings possible from 0,01 to 2 500 pulses/minute

Applications

- In connection with a pulse generator for oil and grease to reliably monitor lubricant flow

Technical data

Function principle	universal electronic control and monitoring device
Operating temperature	0 to +60 °C +32 to 140 °F
Output voltage	24 V DC +10% / -15%
Dimensions	70 × 75 × 110 mm 2.7 × 3 × 4.3 in

Version + 471

Input voltage	100–120 V AC; 200–240 V AC
Input current rated	70 mA/35 mA
Power input	8 W
Frequency	50 – 60 Hz
Fuse	max. 6.3 A
Switching current	max. 5 A
Output voltage sensors	24 V DC

Version + 472

Input voltage	20 to 24 V DC; 20 to 24 V AC
Input current rated	75 mA at max. fan-out of 250 mA
Power input	5 W
Frequency	DC or 50 – 60 Hz
Fuse	max. 6.3 A
Switching current	max. 5 A
Output voltage sensors	24 V DC

Order information

Order number	Description
EWT2A01-S1-E+471	for up to 3 pulse generators, 115/230 V AC
EWT2A01-S1-E+472	for up to 3 pulse generators, 24 V DC
EWT2A04-S1-E+471	for up to 2 pulse generators, 115/230 V AC
EWT2A04-S1-E+472	for up to 2 pulse generators, 115/230 V AC

NOTE

For further technical information, technical drawings, accessories, spare parts or product function descriptions, see the following publications available on SKF.com/lubrication:

1-1700-5 EN, 951-180-001 EN

Monitoring devices

234-11145-3/4/5/9



Description

These virtually maintenance-free electronic pressure sensors are suitable for pressure measurements for gases and fluids. They are user friendly and can be applied easily in standard or superior applications. The space-saving housing is pivotable up to 320° for optimal readability of the 4-digit, digital display. One or two switching outputs and an analog output signal for switching point and hysteresis. Both can be adjusted via push buttons. Different value units such as bar, mbar, psi or MPa can be selected.

Features and benefits

- Simple monitoring of lubrication points
- Menu-guided adjustments via 2 push buttons
- Pre-adjustable hysteresis
- Reverse polarity protection of the supply voltage, excess voltage, override and short circuit protection are provided
- Compact housing with 320° pivot

Applications

- Marine, off-shore applications
- Wind, vehicle, steel and heavy industries

Technical data

Function principle	Digital pressure switch
Lubricant	oil and fluid grease NLGI 000–00, grease NLGI 1, 2
Operating temperature	–25 to +125 °C; –13 to +257 °F
Operating pressure	max. 600 bar; max. 8 700 psi
	234-11145-5:
	max. 400 bar; max. 5 800 psi
Operating voltage	18–36 VDC
Operating current	max. 500 mA
Current draw	≤ 50 mA
Output signal	1 or 2 × PNP; 1 analog, digital, NO or NC adjustable
Switching frequency	max. 200 Hz
Switching point adjusted	234-11145-5: 175 bar; 2 465 psi
Material:	
Housing	PA6.6, stainless steel, FKM
Measuring cell	ceramics Al2O3
Adapter	stainless steel
Electrical connection	M12 × 1; 4 pin plug
Pressure port	G 1/4 or G 3/8; DIN3852
Protection class	IP 67; EC 60529
Dimensions	min. 34 × 94 × 49 mm max. 34 × 134,5 × 49 mm min. 1.34 × 3.7 × 1.9 in max. 1.34 × 5.3 × 1.9 in
Mounting position	any

Order number

Order number	Designation
234-11145-3	1 × PNP, 4–20 MA, with adapter G 1/4 and connector
234-11145-4	1 × PNP, 4–20 MA, basic model
234-11145-5	2 × PNP, 0–20 MA, with adapter G 1/4 and connector, front flushed
234-11145-9	1 × PNP, 4–20 MA, with adapter G 3/8 and connector



NOTE

Further technical information, technical drawings, accessories, spare parts or product function descriptions available on SKF.com/lubrication.

Monitoring devices

234-10825-8



Description

This pressure switch reliably monitors pressure in lubrication systems at a pre-adjusted pressure value. When adjusted value is reached, pressure switch opens or closes an electric circuit via a defined piston stroke (depending on pressure power and pre-load spring). A micro switch can be used for DC or AC voltage. The switch's housing can be pivoted up to 360°. The pre-adjusted switching point pressure value is set at the factory.

Features and benefits

- Simple, mechanically operated pressure switch for monitoring of lubrication points
- Designed as a change-over pressure switch
- Monitors a pre-adjusted pressure value
- Suitable for DC and AC voltage
- Pivotal housing up to 360°
- Maintenance free

Applications

- Machine tools
- Construction machinery
- Wind energy
- Vehicle
- Steel and heavy industries

Technical data

Order number	234-10825-8
Function principle	rotatable pressure switch
Lubricant	oil and fluid grease NLGI 000, 00
Operating temperature	-25 to +85 °C -13 to +185 °F
Operating pressure	max. 400 bar max. 5 800 psi
Switching pressure	100 to 400 bar 1 450 to 5 800 psi
Adjustability	under pressure
Operating voltage	adjustable: 30 to 250 VDC; 125; 250 VAC
Load resistance	0,25-5 A
Load inductive	0,25-5 A
Switch type	micro switch with spring-loaded piston
Contact type	change-over
Contact electrical	plug connector DIN72585 ø 2,5 mm
Material:	
Housing	zinc-coated steel, UR
Contact electrical	electroplated silver gilt
Protection class	IP 67, IP 6K9K
Dimensions	30 × 74 mm; 1.18 × 2.91 in
Mounting position	any, but preferably vertical



NOTE

Further technical information, technical drawings, accessories, spare parts or product function descriptions available on SKF.com/lubrication.

Index

406-001.....	13	24-0701-3081	27	24-1557-3522.....	27
406-002	13	24-0701-3072.....	27	24-0413-3490	27
404-001.....	13	24-0701-3082	27	95-0006-0917	27
404-002	13	24-0701-3073.....	27	24-0801-2070	27
44-1202-2038	13	24-0701-3083	27	744-000-0107.....	29
44-0606-6302	13	24-0701-3074.....	27	24-2317-2017.....	29
24-1557-3520.....	15	24-0701-3084	27	PFHM-6-B6-C3-ATEX	33
24-1557-3521.....	15	24-1721-2000.....	27	PFHM-6-B6-C5-ATEX	33
24-1557-3522.....	15	24-1721-2001.....	27	KFG1.U0.....	33
880550	17	24-0701-3004	27	KFG1.U0-C5M	33
880560	17	24-0701-3035	27	KFG1.U1	33
880553	17	24-0701-3036	27	KFG1.U1-C5M	33
880551.....	17	24-0701-3003	27	KFG1.U2.....	33
880561.....	17	24-0701-3004	27	KFG1.U2-C5M	33
880552.....	17	24-0701-3037.....	27	KFG1.U3.....	33
880554	17	24-0701-3038	27	KFG1.U3-C5M	33
880463	17	24-0701-3039	27	KFG1.U4.....	33
880555	17	24-0701-3040	27	KFG1.U4-C5M	33
880556	17	24-0701-3041.....	27	161-210-075.....	33
880496	17	24-0701-3042	27	161-210-079.....	33
350654.....	17	24-0701-3043	27	161-210-076.....	33
250132.....	17	24-0701-3044	27	161-210-080.....	33
70224.....	17	24-1721-2000.....	27	161-210-077.....	33
276517	17	24-1721-2001.....	27	161-210-081.....	33
161-140-050+924	21	44-0717-2060.....	27	24-1557-3520.....	35
161-140-056+924.....	21	44-0717-2061.....	27	24-1557-3521.....	35
24-1884-2324	21	44-0717-2062.....	27	24-1557-3522.....	35
24-1884-2397	21	44-0717-2063.....	27	44-0717-2070.....	35
24-2578-2041.....	21	44-0717-2064.....	27	44-0717-2071.....	35
24-2578-2044	21	DIN125-B6.4-ST.....	27	44-0717-2072.....	35
24-0404-2493	23	DIN934-M6-8	27	DIN125-B6.4-ST.....	35
24-1557-3560.....	23	44-0717-2069.....	27	DIN934-M6-8	35
24-1751-2760.....	23	44-0717-2070.....	27	24-0254-2312	35
24-0651-3519.....	23	44-0717-2071.....	27	24-0254-2334	35
24-0701-3000	27	44-0717-2072.....	27	24-0254-2330	35
24-0701-3070	27	44-0717-2073.....	27	24-0254-2310	35
24-0701-3080	27	DIN125-B6.4-ST.....	27	24-0254-2335	35
24-0701-3001	27	DIN934-M6-8	27	24-0254-2331	35
24-0701-3002	27	24-1557-3520.....	27	600-27464-2.....	37
24-0701-3071.....	27	24-1557-3521.....	27	600-26876-2	37

Index

600-26877-2	37	600-25046-3	49	24-2583-2516	60
655-28716-1	37	303-19285-1	49	24-2583-2517	60
303-19285-1	37	624-25478-1	49	24-2583-2526	60
624-29056-1	37	624-25479-1	49	13120202	60
624-29054-1	37	624-25480-1	49	13120204	60
304-17571-1	37	624-25481-1	49	EWT2A01-S1-E+471	61
304-17574-1	37	624-25482-1	49	EWT2A01-S1-E+472	61
660-77835-1	41	624-25483-1	49	EWT2A04-S1-E+471	61
660-77619-1	41	304-17571-1	49	EWT2A04-S1-E+472	61
303-17431-1	41	304-17574-1	49	234-11145-3	62
624-25483-1	41	236-10850-7	54	234-11145-4	62
624-28362-1	41	236-10850-8	54	234-11145-5	62
600-27464-2	43	236-10850-9	54	234-11145-9	62
600-25046-3	43	236-10980-6	54	234-10825-8	63
600-25047-3	43	664-34135-7	54		
303-19285-1	43	236-10567-6	55		
624-25478-1	43	236-10567-5	55		
624-25479-1	43	086500	56		
624-25480-1	43	086501	56		
624-25481-1	43	086502	56		
624-25482-1	43	086503	56		
624-25483-1	43	086506	57		
304-17571-1	43	086507	57		
24-1557-3680	47	3515-10-6020	57		
24-1557-3681	47	3515-10-6620	57		
24-1557-3683	47	3515-10-7620	57		
24-2255-2003	47	3515-10-6220	57		
24-2255-2004	47	3515-10-6320	57		
24-2255-2005	47	3515-07-6120	57		
660-77835-1	47	3515-10-2021	57		
660-77619-1	47	3515-07-2022	57		
24-2103-2273	47	179-990-486	57		
24-2103-2344	47	236-11066-1	57		
24-2103-2345	47	236-10850-7	57		
24-2103-2342	47	236-10850-8	57		
24-2103-2272	47	236-10850-9	57		
24-2103-2346	47	236-10980-6	57		
24-2103-2271	47	086504	57		
600-27464-2	49	086505	57		
600-25047-3	49	234-10825-8	59		



Important information on product usage

SKF and Lincoln lubrication systems or their components are not approved for use with gases, liquefied gases, pressurized gases in solution and fluids with a vapor pressure exceeding normal atmospheric pressure (1.013 mbar) by more than 0,5 bar at their maximum permissible temperature.



skf.com | skf.com/lubrication | lincolnindustrial.com

© SKF and LINCOLN are registered trademarks of the SKF Group.

© SKF Group 2020

The contents of this publication are the copyright of the publisher and may not be reproduced (even extracts) unless prior written permission is granted. Every care has been taken to ensure the accuracy of the information contained in this publication but no liability can be accepted for any loss or damage whether direct, indirect or consequential arising out of the use of the information contained herein.

PUB LS/P1 17478 EN · February 2020

This publication supersedes W-113-EN.

Certain image(s) used under license from Shutterstock.com